



**INSTALLATION AND OPERATING MANUAL
COSMO FRESH WATER MODUL
CFWMEXL / CFWMVEEXL**



Content

1	Scope of delivery	3
1.1	Delivery and transport.....	4
2	Standards and guidelines	4
3	Safety	5
3.1	Safety instructions	5
4	General information regarding the installation and operating manual	6
4.1	Regulation.....	6
4.2	Settings.....	6
5	Product description.....	7
5.1	Intended purpose.....	7
5.2	Applicable documents.....	7
6	Technical specifications.....	8
6.1	General instructions.....	8
6.2	Dimensions / required space	9
6.3	Pressure loss / pump characteristic curve	9
6.4	Corrosion protection	10
6.5	Calcification protection.....	11
6.6	Pump information.....	12
6.7	Gravity brake	12
7	Assembly and installation	13
7.1	Valve assembly.....	13
7.2	Wall-mounted assembly	14
7.3	Hydraulic connection with accessories	15
7.4	Electrical connection.....	18
8	Commissioning, functional test, Decommissioning.....	19
8.1	Start-up.....	19
8.2	Troubleshooting.....	20
8.3	Temperature sensor / Flow sensor	20
8.4	Decommissioning	21
9	Maintenance.....	22
9.1	Cleaning the heat exchanger	22
10	Replacement parts / accessories	22
11	COSMO hotline	23
12	EU Declaration of Conformity	23
13	Warranty, availability guarantee, imprint.....	24

1 Scope of delivery

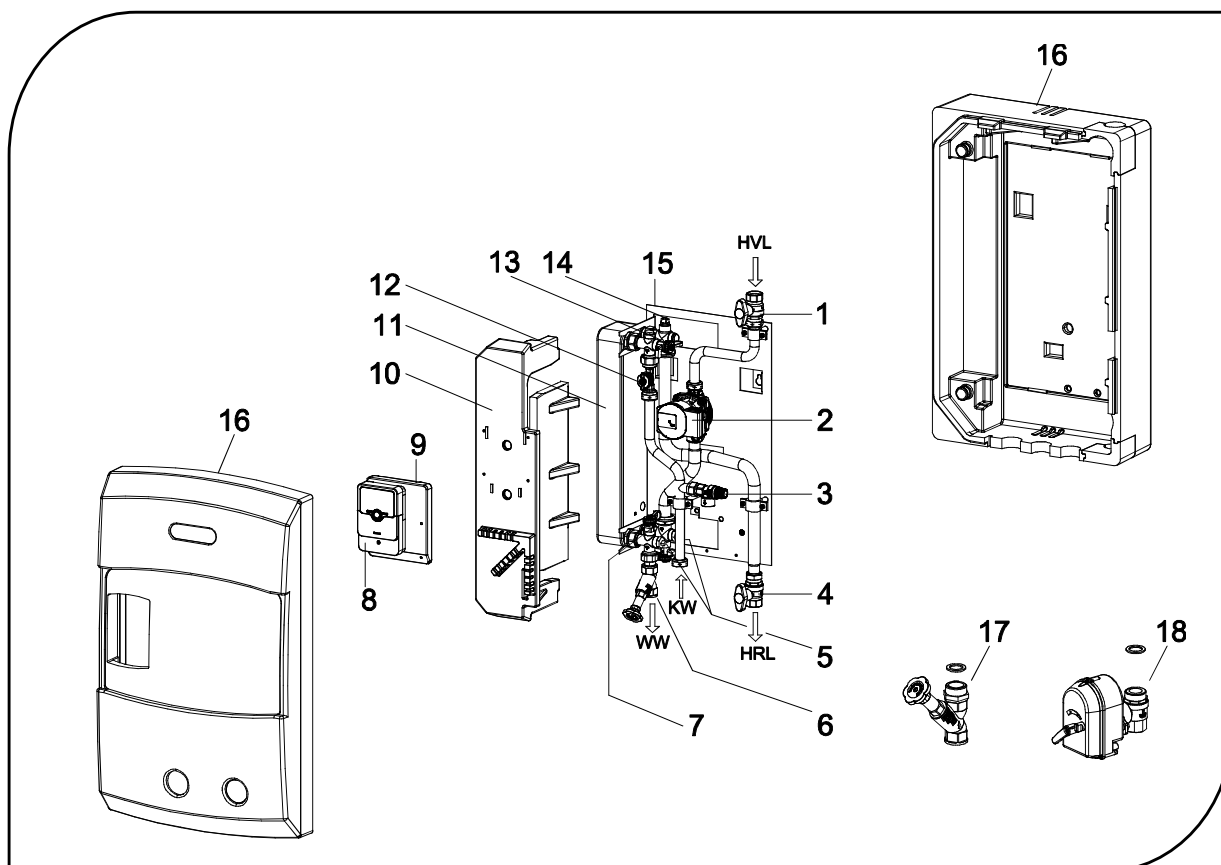

Pos.	Bezeichnung
1	Ball valve for heating flow (HVL)
2	Circulation pump
3	Safety valve
4	Ball valve for heating return (HRL)
5	Front: HW temperature sensor
6	Shut-off valve for hot water (WW)
7	Flush valve/drain (WW)
8	Control unit
9	Bracket for control unit
10	Plate heat exchanger insulation plate
11	Plate heat exchanger
12	Flow sensor 3,5-50 l/min
13	Type 235
14	Flush valve for cold water (KW)
15	Cross piece including backflow preventer and hand vent valve
16	Mounting plate
17	Shut-off valve for cold water (KW) (required for single station)
18	Cascade valve (KW) + actuator (required for cascade station)
KW	Cold water
WW	Hot water

The Replacement parts number can be found under 10 Replacement parts / accessories

1.1 Delivery and transport

Check to make sure the product is complete and undamaged immediately after receipt. Any damage or complaints must be reported immediately.

Observe the labels on the packaging without fail! The fresh water modul should only be removed from its packaging at the place of installation.

2 Standards and guidelines

Please observe the following standards, regulations and guidelines with regard to installation and operation:

- DIN EN 806 / DIN EN 1717 / DIN EN 806 / DIN 4708 / EN 12975
- DVGW worksheet W 551 / worksheet W 553
- EnEG (Energy Conservation Act)
- EnEV (Energy Saving Ordinance)
- Local regulations
- DIN 18 380 (Heating systems and central water heating systems)
- DIN 18 381 Gas, water and wastewater installation work
- DIN 18 421 Thermal insulation work on thermotechnical systems
- VDI 2035 (Prevention of damage in water heating installations)
- DIN 4753 (Water heaters and water heating installations for drinking water and service water)
- VDE 0100 (Installation of electrical equipment)
- VDE 0190 (Main equipotential bonding of electrical systems)
- TrinkwV (Drinking Water Ordinance)
- BGV (Accident prevention regulations of workers' compensation associations)

3 Safety

3.1 Safety instructions

In addition to country-specific guidelines and local directives, the following technical regulations must also be taken into account:



Important - risk of burning!

- As the system can reach temperatures > 60 °C, there is a risk of scalding and burning through contact with the components.



Danger – Electric shock!

- Risk of fatal electric shock as a result of incorrect electrical connections.
- Electrical connections must exclusively be created by electricians approved by energy suppliers and as per the locally applicable regulations.
- Disconnect the supply voltage prior to conducting any work.



Attention: Observe the water quality!

- Risk of calcification: For mass concentrations of calcium carbonate of > 1.5 mmol/l, the primary temperature must be limited to < 65°C. For mass concentrations of calcium carbonate of > 2.5 mmol/l, a softening system must be installed.
- Corrosion: If the limit values under point 6.4 are exceeded, a solid stainless steel heat exchanger must be used.
- Solid stainless steel heat exchangers are to be used for aggressive drinking water qualities that exhibit an electrical conductivity of > 500 µS/cm; please observe the detailed limit value table

The respective personal protective equipment must be worn when conducting any work on the system/device; this includes ear protection, eye protection, safety shoes, hard hat, protective clothing and protective gloves. Information regarding the personal protective equipment can be found in the national directives of the respective country of operation.

4 General information regarding the installation and operating manual

This manual describes the installation, operation and maintenance of the **CFWMEXL/CFWMVEEXL** fresh water modul.

This manual is intended for trained specialists with an adequate level of expertise in handling heating systems, water pipe installations and electrical installations.

The installation and commissioning procedures should only be conducted by qualified, specialist personnel.

The fresh water modul must only be installed and operated in dry areas that are protected from frost.

Read this manual carefully before starting any installation work.

Non-compliance will invalidate all claims under the guarantee and warranty.

Illustrations are symbolic and may differ from product to product.

Subject to technical changes and errors.

This installation and operating manual must not be reproduced or made available to third parties without prior written consent (section 2 German Copyright Act, section 823 Civil Code).

This installation and operating manual is to be handed over to the system operator and kept in close proximity to the device.

4.1 Regulation

Observe the installation and operating instructions for the control unit used.

4.2 Settings

Set the hot water temperature and the circulation programme if necessary.

Observe the installation and operating instructions for the control unit used.

5 Product description

5.1 Intended purpose

The CFWMEXL/CFWMVEEXL fresh water module is an electronically controlled hydraulic assembly for heating drinking water based on a flow principle.

The tapping flow rate is recorded via an electronic flow rate sensor that has a measuring range ex 2 l/min. The required primary flow rate is determined from the temperature of the storage tank, the flow rate and the nominal temperature of the hot water. In order to achieve a constant hot water temperature, the speed of the primary pump is varied by means of a PWM signal.

The CFWMEXL CFWMEXL/CFWMVEEXL fresh water module should only be used to heat drinking water in accordance with the Drinking Water Ordinance. The primary circuit must be filled with heating water according to VDI 2035.

The CFWMVEEXL fresh water module features solid stainless steel heat exchangers and is intended for aggressive drinking water supplies.

5.2 Applicable documents

Also observe the installation and operating instructions for the various components used, such as the control unit.

6 Technical specifications

6.1 General instructions

Designation/type		COSMO CFWMEXL/CFWMVEEXL
Nominal output at 10-45/65°C (CW-HW/HF)		158 kW
Tapping capacity at nominal output		65 l/min
NL number at nominal output		23
Tapping capacity at 10-60/75°C (CW-HW/HF)		50 l/min
Output at 10-45/65°C (CW-HW/HF; incl. cascades)		158 / 300 / 450 / 600 kW
Tapping capacity at 10-45/65°C (incl. cascades)		65 / 124 / 185 / 247 l/min
NL number (incl. cascades)		23 / 47 / 87 / 133
Tapping capacity at 10-60/75°C, mixed to 45°C HW (incl. cascades)		50 / 95 / 143 / 190 l/min
Max. operating pressure	Heating circuit Drinking water	3 bar 10 bar
Max. operating temperature	Heating circuit Drinking water	95 °C 65 °C
Connections	Heating circuit Drinking water	G1 Rp ³ / ₄
Pressure loss on the service water side at nominal output		0,8 bar
Max. pressure loss for piping on the heating side		50 mbar
Circulation pump Power input		Wilo Para 15/8 iPWM2 3-87 W
Flow rate sensor		Sensor Type 235 DN 15
Electrical connection (mains control unit)		230 V AC/ 50-60 Hz
Materials		
Housing/connecting components		CW617N (2.0402)
Plate heat exchanger CFWMEXL		Stainless steel, Cu soldered
Plate heat exchanger CFWMVEEXL		Stainless steel, stainless steel soldered
Seals		AFM
Insulation		EPP foam 0.038 W/mK

6.2 Dimensions / required space

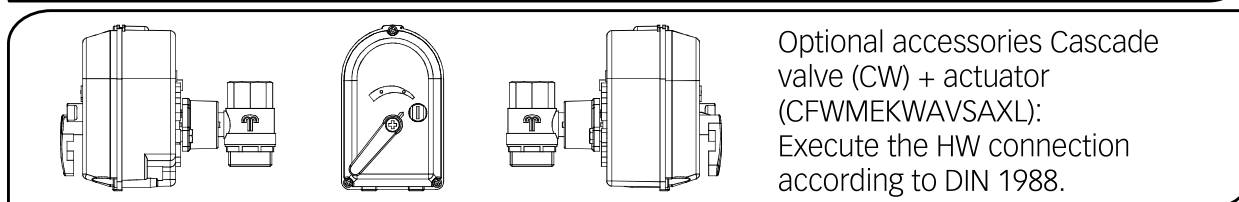
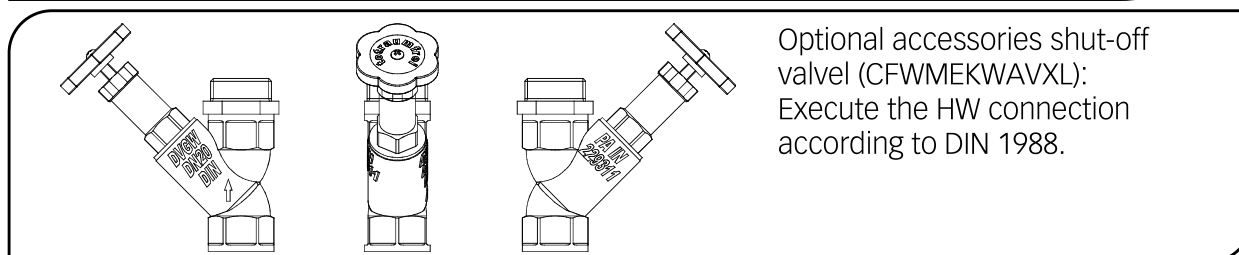
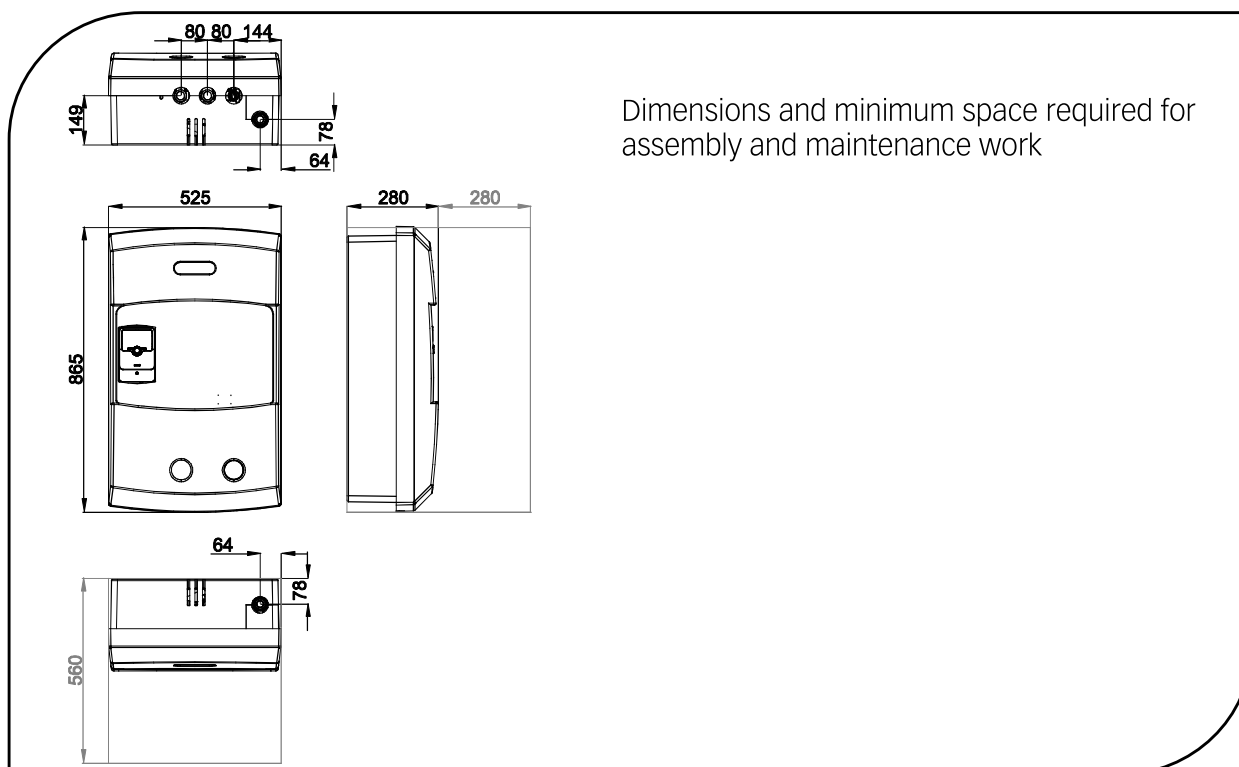

6.3 Pressure loss / pump characteristic curve

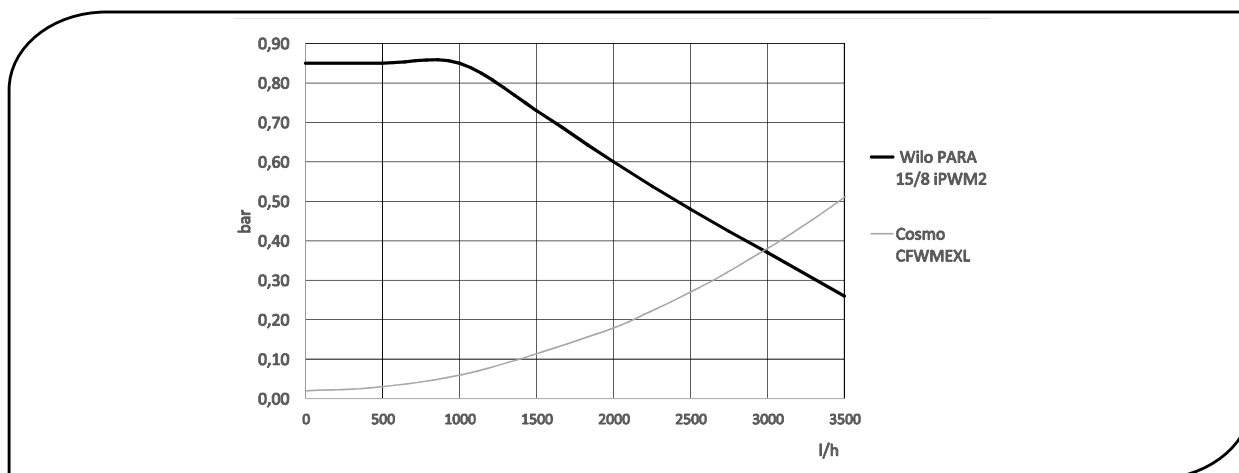

Specified pressure loss valid for heating side (primary) and drinking water side (secondary).

6.4 Corrosion protection

To prevent corrosion damage to plate heat exchangers, the following drinking water values must be observed:

	Copper-soldered	Solid stainless steel
Chloride (CL ⁻)		< 250 mg/l at 50°C < 100 mg/l at 75°C < 10 mg/l at 90°C
Sulphate ¹ (SO ₄ ²⁻)	< 100 mg/l	< 400 mg/l
Nitrate ¹ (NO ₃ ⁻)	< 100 mg/l	No requirement
pH value ¹	7,5 - 9,0	6 – 10
Electrical conductivity ¹ (at 20°C)	10 - 500 µS/cm	No requirement
Hydrogen carbonate ¹ (HCO ₃ ⁻)	70 - 300 mg/l	No requirement
Ratio ¹ HCO ₃ ⁻ / SO ₄ ²⁻	> 0,5	No requirement
Ammonia ¹ (NH ₄ ⁺)	< 2 mg/l	No requirement
Free chlorine gas		< 0,5 mg/l
Sulphite ¹	< 1 mg/l	< 7 mg/l
Ammonium		< 2 mg/l
Hydrogen sulphide ¹ (H ₂ S)	< 0,05 mg/l	No requirement
Free (aggressive) carbon dioxide ¹ (CO ₂)	< 5 mg/l	No requirement
Iron ¹ (Fe)	< 0,2 mg/l	No requirement
Saturation index ¹ SI	-0,2 < 0 < 0,2	No requirement
Manganese ¹ (Mn)	< 0,05 mg/l	No requirement
Degree of hardness (°dH)		4 – 14 [Ca ²⁺ ; Mg ²⁺]/ [HCO ₃ ⁻] < 0,5
Total organic carbon ¹ (TOC)	< 30mg/l	No requirement

¹ If the limit values for copper-soldered plate heat exchangers are exceeded, a solid stainless steel plate heat exchanger must be used.



To prevent pitting corrosion in the domestic installation, no new galvanised iron material must be installed downstream in the hot water pipe of the copper-soldered plate heat exchanger without forming a protective layer.

Solid stainless steel plate heat exchangers must be used in mixed installations with zinc-coated iron materials.

The grounding of the fresh water station must be ensured so that no current flow through the heat exchanger triggers electrochemical corrosion (see chapter 7.4.3 Equipotential bonding).



On the buffer tank side (primary side), the heating water quality must fulfill the requirements of VDI 2035.

6.5 Calcification protection

Limescale deposits from the water increase significantly at temperatures $>55^{\circ}\text{C}$ and a water hardness level over 8.5°dH . Because of that the hot water temperature should be set as low as possible taking the drinking water hygiene into account. If necessary reduce calcification by using water softeners or different suitable method.

It should be noted that decalcification using ion exchange does not reduce conductivity. For this reason, a full stainless steel exchanger must be used from $500\ \mu\text{S} / \text{cm}$. It can be calculated that $14^{\circ}\ \text{dH}$ corresponds to a conductivity of $14^{\circ}\ \text{dH} * 35 = 490\ \mu\text{S} / \text{cm}$. For safety's sake, a full stainless steel exchanger must be used.

Refer to the Maintenance section for recommendations on cleaning.

Water treatment measures to prevent scale formation (water softening)

	Fresh water modul with 50°C hot water-tapping temperature and	
Mass concentration of calcium carbonate	primary flow $<65^{\circ}\text{C}$	primary flow $>65^{\circ}\text{C}$
$< 1.5\ \text{mmol/l}$ ($< 150\ \text{mg/l}$) $< 8.4^{\circ}\text{dH}$	None	None
$1.5\ \text{to}\ 2.5\ \text{mmol/l}$ ($150\ \text{to}\ 250\ \text{mg/l}$) $8.4^{\circ}\text{dH}\ \text{to}\ 14^{\circ}\text{dH}$	None	Recommended
$> 2.5\ \text{mmol/l}$ ($> 250\ \text{mg/l}$) $> 14^{\circ}\text{dH}$	Recommended	Required

6.6 Pump information

PWM-Logik (iPWM2)

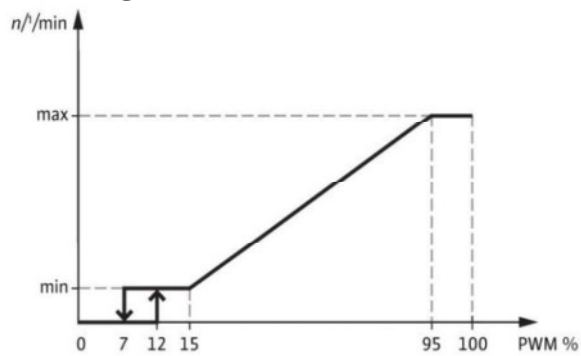

< 7% pump off
 7-12% Min. output (operation)
 12-15% min. output (start-up)
 15-95% proportional output range
 > 95% max. output

6.7 Gravity brake

A gravity brake (SKB) is installed in the heating return (HRL) to prevent incorrect circulation. (see fig.)

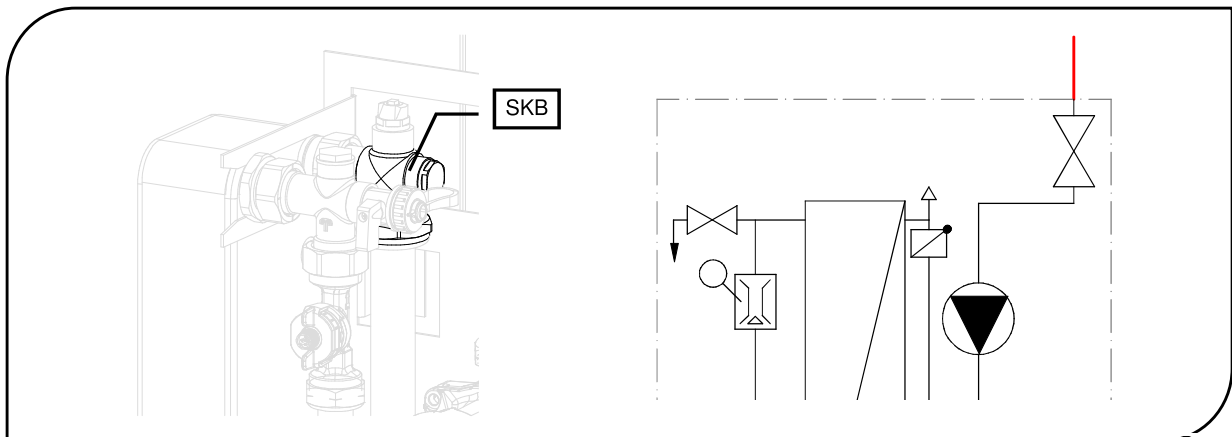

7 Assembly and installation

7.1 Valve assembly

7.1.1 Shut-off valve (CW)

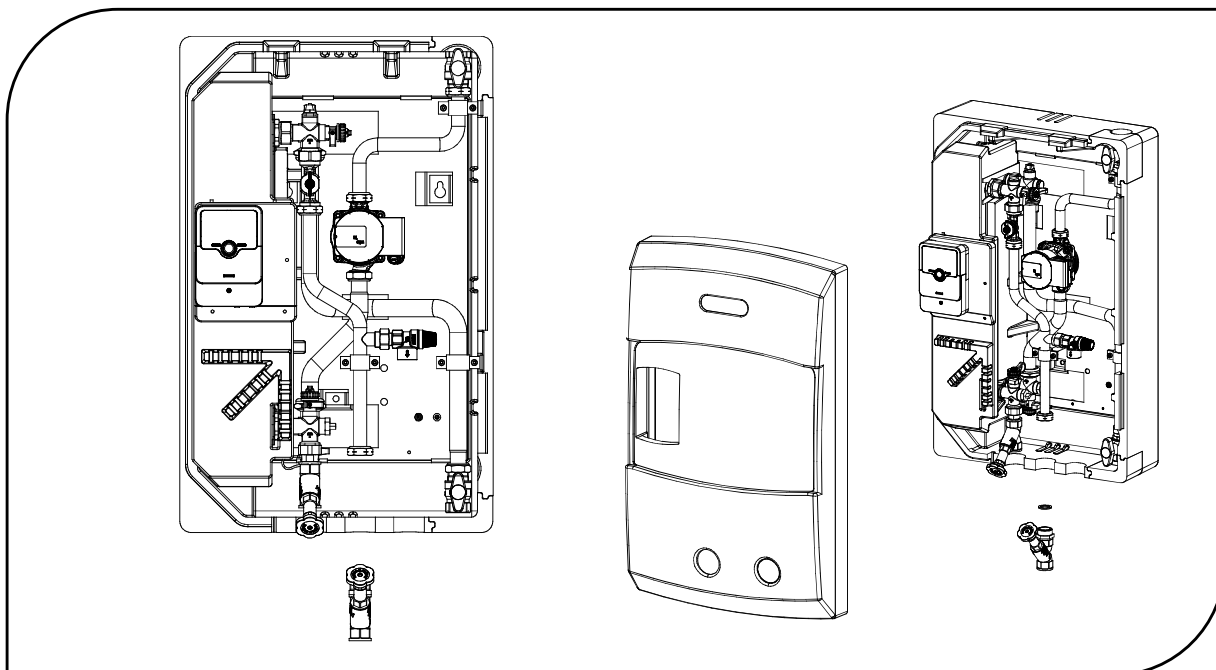

7.1.2 Cascade valve (CW)

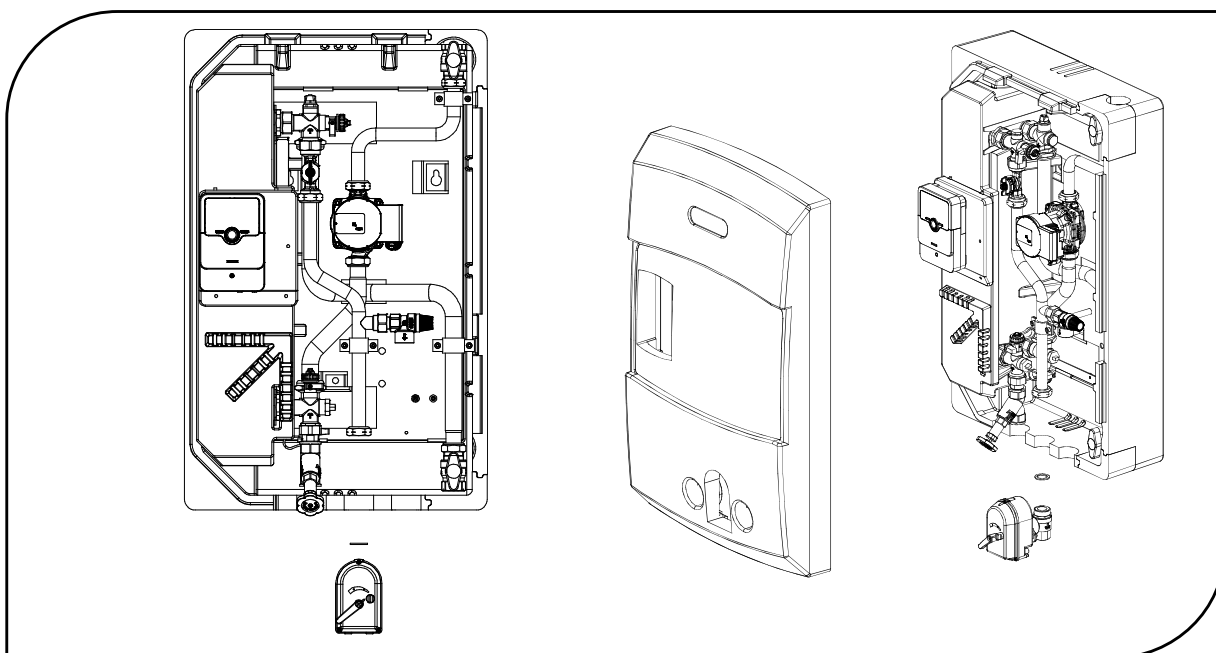

7.2 Wall-mounted assembly

7.2.1 Dimensions

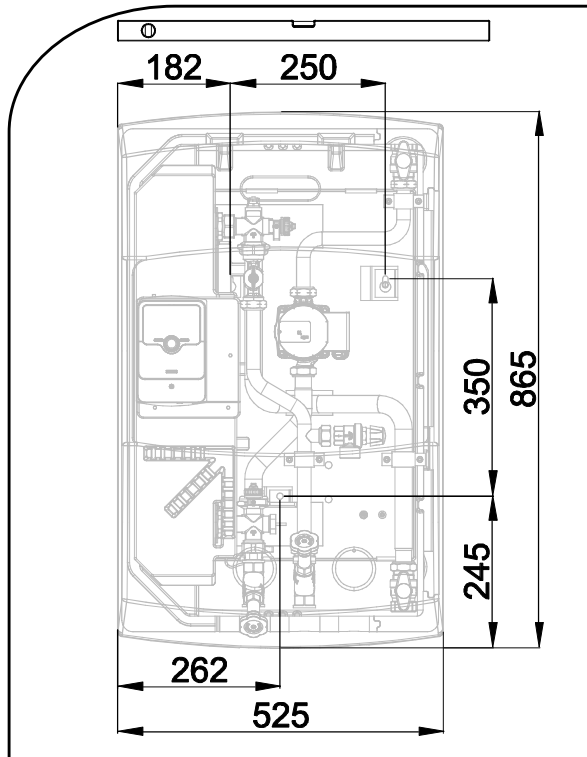

Mark the drilling dimensions as per the drawing and drill with 10 mm.

Insert the rawl plugs.

Tighten the two top screws. Tighten to a clearance of 3 mm between the screw head and the wall.

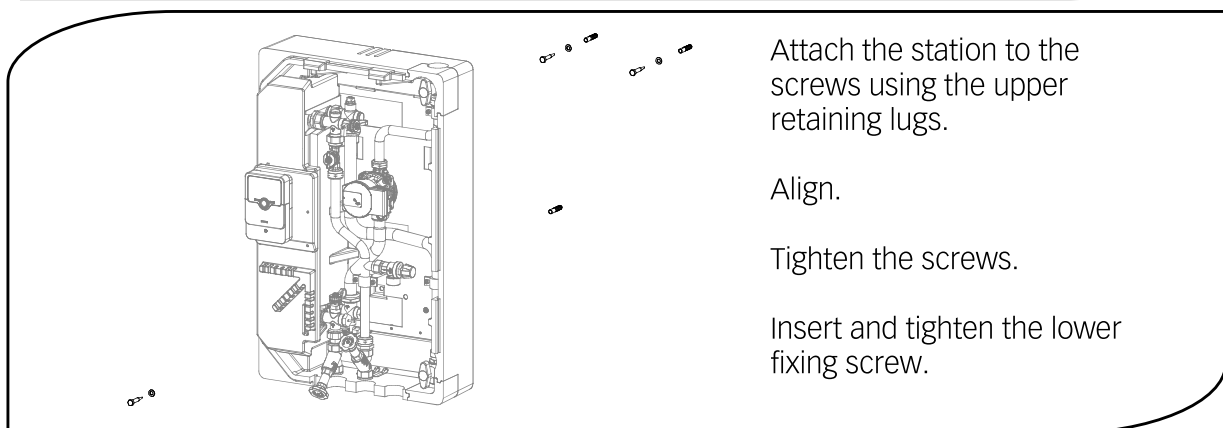

Attach the station to the screws using the upper retaining lugs.

Align.

Tighten the screws.

Insert and tighten the lower fixing screw.

7.2.2 Installation requirements

- The upper flow pipe can be shortened. The lower pipe has a constant length
- The distances between the connections are within the illustrated range.
- For further information, please refer to the separate instructions for the connection set.

7.3 Hydraulic connection with accessories

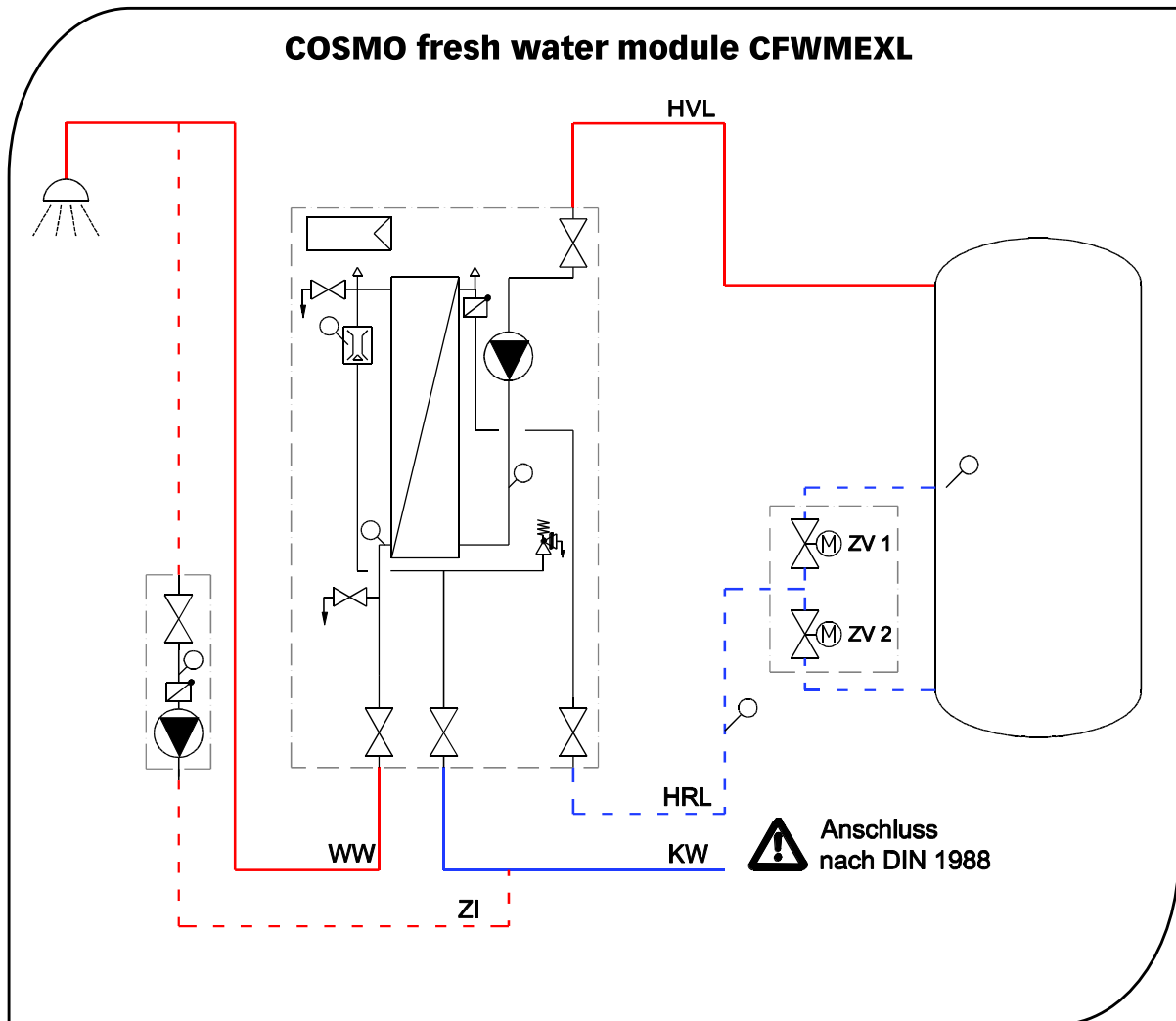

Designation	Description
WW	Hot water
KW	Cold water
HVL	Heating flow
HRL	Heating return
ZI	Circulation
ZV1	Zone valve 1
ZV2	Zone valve 2

CFWMERES32: Return stratification with 2 zone valve and two PT1000 temperature sensors (storage tank center & storage tank return)

Electrical connection for return stratification

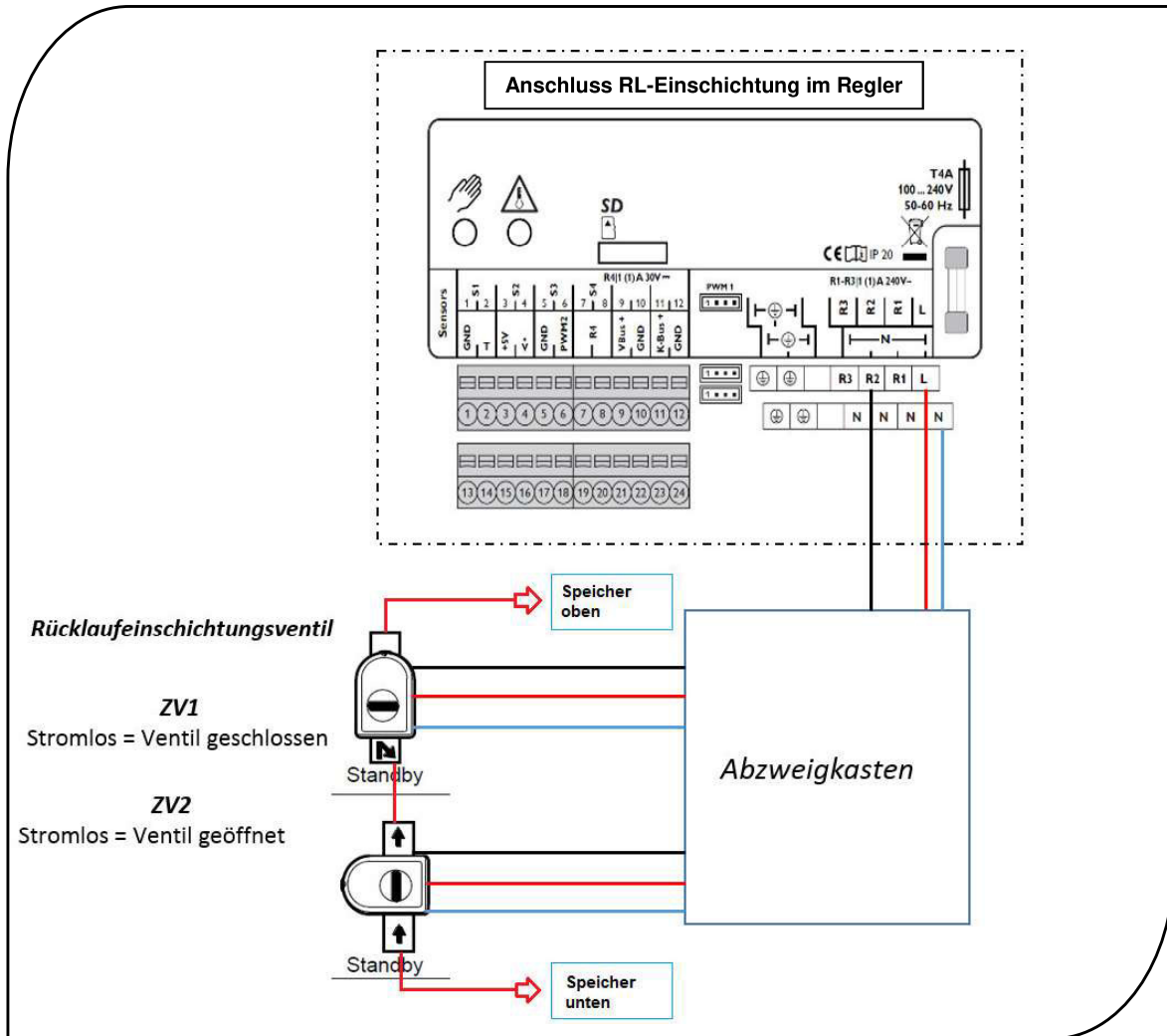

Optional circulation set

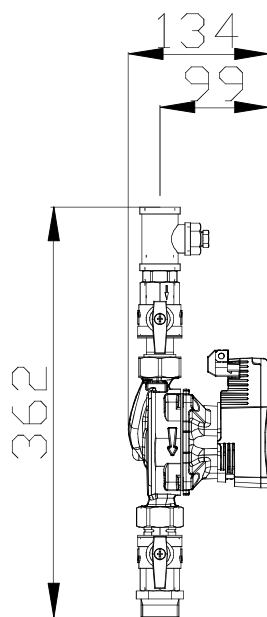

Description:

The CFWMEZS circulation set is an optional accessory for the CFWMEXL system. The set consists of the circulation pump, 2 shut-off ball valves with a backflow preventer and a thermowell with PT1000 sensor. A temperature sensor is always required for all circulation methods.

Dimensions and minimum space required for assembly and maintenance work.

The temperature difference between the circulation return and hot water is adjusted via the red adjusting knob on the pump

For further information, please refer to the separate instructions for the circulation set.

Optionale expansion vessel

Connection expansion vessel

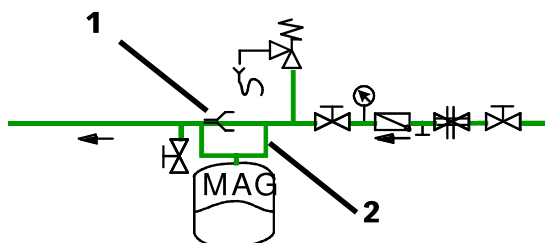

Pos. 1 - Injection nozzle (Venturi)

Pos. 2 - Bypass \varnothing 22mm

Recommended minimum cross-section of KW pipe in front of press-in nozzle:

Volume flow max. 2 m³/h = 22mm

Volume flow max. 4 m³/h = 28mm

Volume flow max. 6 m³/h = 35mm

Volume flow max. 8 m³/h = 42mm

Up to 200 litres pipe content (TWW+circulation+FWM) is a 8 litre COSMO TWW expansion vessel incl. flow-through fitting (Reflex Flowjet) is sufficient.

7.4 Electrical connection

7.4.1 General instructions



Only authorised, specialist personnel are permitted to open electrical housings and work on the electrical system after de-energising the equipment. When establishing connections, make sure the terminal assignments and polarity are correct. Protect the control unit and electrical components against excess voltage.

The fresh water modul **CFWMEXL / CFWMVEEXL** is pre-installed and wired ex works. Connect the power cable to commission.

Please refer to the separate control unit instructions for more details.

7.4.2 Circulation pump

The pump is controlled exclusively via an external PWM signal. The green flashing LED display indicates the standby mode. A green continuous light indicates the pump is operating at a speed corresponding to the PWM signal. A red LED signals an error.

Electrical pump connection

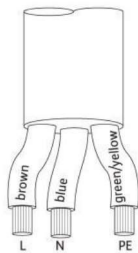

L = brown
N = blue
PE = green/yellow

PWM connection



+ = brown
- = blue

7.4.3 Equipotential bonding

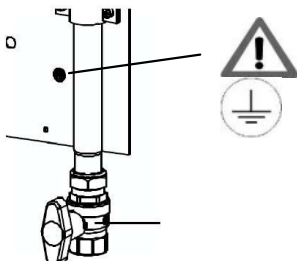

The terminal point on the mounting plate must be professionally connected to the building potential equalization

7.4.4 Regulation

Refer to the separate operating manual of the corresponding control unit for more detailed information.

8 Commissioning, functional test, Decommissioning

Complete installation of all hydraulic and electrical components is a precondition for commissioning.

8.1 Start-up

8.1.1 Leak testing and filling the system

Check all system components, including all pre-fabricated elements and stations, to ensure they are leak-tight; seal any detected leaks accordingly. When doing so, adapt the test pressure and test duration to match the respective piping system and the respective operating pressure.

Fill the drinking water side with clean drinking water as per DIN 1988 only; bleed the air from the system by gradually increasing the pressure.



Note:
Tapping flow rates of > 70 l/min are to be avoided, as these can in long term result in permanent damage to the sensor.

Open the taps and slowly open the ball valve.

Only fill the heating system, including the primary side of the fresh water system, with water as per VDI 2035; bleed the system completely.

8.1.2 Initial commissioning process and functional test

Please observe the corresponding instructions for the control unit.

Task	Procedure	OK
Preparation and inspection	<ul style="list-style-type: none"> • Visual inspection of the installation. • Are all of the sensors installed and connected at the correct locations? • Are all outputs connected? 	<input type="checkbox"/> <input type="checkbox"/> <input type="checkbox"/>
Switch on the control unit	Supply power to the control unit	<input type="checkbox"/>
Set up the control unit	Please observe the instructions for the control unit. <ul style="list-style-type: none"> • Set the fresh water temperature (hot water temperature). • Adjust the circulation (optional). • Adjust the return stratification (optional) • Configure the cascades (optional) 	_____ - _____ _____
Additional settings	<ul style="list-style-type: none"> • Adjust the pre-mix valve (optional) 	_____
Test the outputs	Activate all of the outputs individually in sequence and check to make sure the pumps switch correctly.	<input type="checkbox"/>
Check function	<ul style="list-style-type: none"> • Check the functionality of the hot water supply. • Check the functionality of the circulation (optional). • Check functionality of the return stratification (optional) • Check functionality of the cascades (optional) 	<input type="checkbox"/> <input type="checkbox"/>

8.2 Troubleshooting

If an error message is output, it appears on the control unit display.
Please observe the corresponding instructions for the control unit.

Malfunction	Possible cause	Remedy
Pump noise	Air in the system	Bleed
Insufficient tapping quantity	Insufficient water pressure	Check pressure, increase if necessary
	Calcification in heat exchanger	Decalcify/replace
Insufficient tapping temperature	Incorrect adjustment on the control unit	Check settings
	Excessive pressure loss in the piping on the heating side	Check the piping, change if necessary
Drinking water does not heat up	Control unit not in operation.	Check control unit
	Air in the system.	Bleed
	HW flow sensor not connected correctly, or defective.	Check, replace if applicable
	Heating flow temperature sensor not connected correctly or faulty.	Check, replace if applicable
	Pump faulty	Check, replace if applicable
	Flow rate sensor defective	Check and replace if applicable

8.3 Temperature sensor / Flow sensor

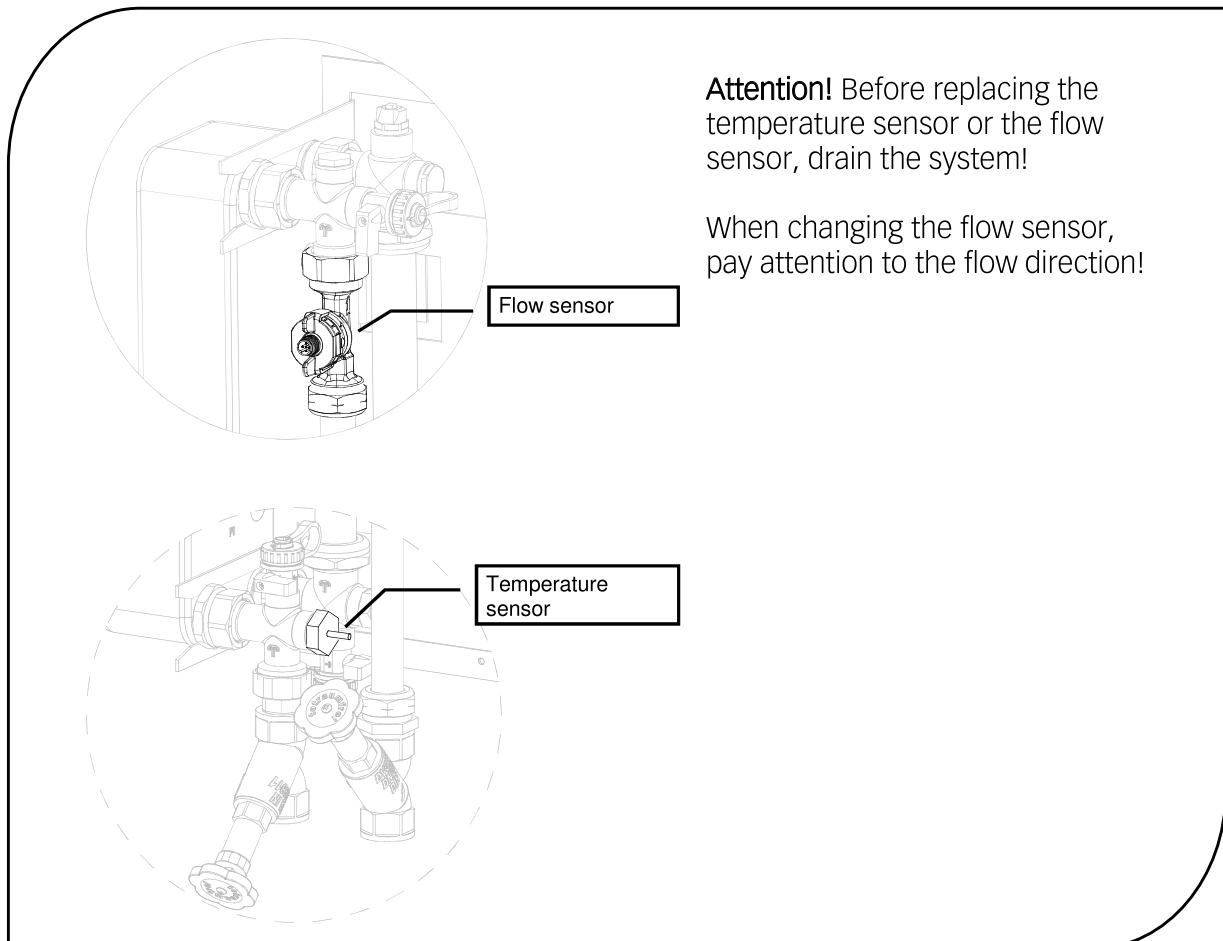

8.4 Decommissioning

If the **CFWMEXL / CFWMVEEXL** is decommissioned for a prolonged period, the power supply must be disconnected.

For final decommissioning of the **CFWMEXL / CFWMVEEXL** the power supply for all of the corresponding system components must be disconnected; all of the relevant pipes and components must be completely drained.

The decommissioning, dismantling and disposal processes should only be conducted by qualified, specialist personnel. Components and materials must be disposed of in accordance with the current applicable regulations.

9 Maintenance

The manufacturer demands having the system serviced annually by authorised, specialist personnel.

Maintenance measures to be carried out:

- Check function, temperature values and volume flow for plausibility,
- Check switching operations of circulation and return-settling,
(use manual operation in the controller for this - then set to AUTO again)
- Switch all ball valves once,
- Check the hot water output, if it has decreased significantly, the heat exchanger must be cleaned => see 9.1 Cleaning the heat exchanger

9.1 Cleaning the heat exchanger

Regularly clean the unit if deposit build-up can be expected due to unfavourable water quality (e.g. extremely hard water or pronounced soiling). The cleaning process restores the original condition of the heat exchanger.

There is the option of cleaning the unit by flushing it. Use the flushing connections in the station for this.

Flush the heat exchanger in the direction opposite to the normal flow direction using a suitable cleaning solution.

Make sure any chemicals used for cleaning are suitable for stainless steel, copper or nickel. Non-compliance may result in permanent damage to the heat exchanger! Use only chloride-free water or water with a low chloride content and water hardness for cleaning solutions. Choose the cleaning agent to match the type of contamination and resistance of the heat exchanger plates. It is important to obtain confirmation from the cleaning agent manufacturer that the cleaning agent will not cause corrosion of the heat exchanger plates to be cleaned. Clean the heat exchanger as per the cleaning agent manufacturer's work instructions. Neutralise any remaining acids in the system after cleaning; passivate all metal surfaces. Passivation is mandatory to prevent any development of corrosion. Always rinse the clean heat exchanger and system using a sufficient amount of fresh water. Always observe the specifications provided by the cleaning agent manufacturer regarding use of the cleaning agent.

10 Replacement parts / accessories

Cosmo ET Number	Bezeichnung	
YCO1301588	Primary pump Wilo Para 15/8 iPWM2	130.15.88.00.18
YCO9076505	Plate heat exchanger CFWMEXL	907.65.05.00.18
YCO9077005	Plate heat exchanger CFWMVEEXL	907.70.05.00.18
YCO9076604	Fresh water controller incl. wiring harness	907.66.04.18.18
YCO0900519	Fresh water-, storage tank sensor Pt1000, G1/2"	090.05.19.00.18
YCO9076507	Flow rate sensor Typ235 DN15	907.65.07.00.18
YCO6004323	CW ball valve	600.43.23.00.18
YCO6004324	HW ball valve	600.43.24.00.18
YCO6722184	Cascade valve DN 20	672.21.84.00.18
YCO4551511	Safety valve	455.15.11.00.18
YCO5841241	KFE valve HW	584.12.41.00.18
YCO5841231	KFE valve CW	584.12.31.00.18
YCO6762645	Ball valve storage tank flow/return	676.26.45.00.18
YCO6004045	Servo motor for cascade valve	600.40.45.00.18

11 COSMO hotline

Technical hotline:

For questions about our products
 Telephone number: +49 (0)4080030 – 430
 Monday to Thursday from 07.15 am to 5.45 pm.
 Fridays from 07.15 am to 12:30 pm.

12 EU Declaration of Conformity

For the following product:

Device: **Fresh water module**
 Type: **CFWMEXL/CFWMVEEXL**

We hereby declare that the design and construction of the products designated below, as well as the version we have introduced, comply with the relevant basic health and safety requirements of the EU Directive – in particular 4004/108/EC, 2006/95/EC, 2014/30/EU, 2014/35/EU, 2011/65/EU and 2009/125/EC. This declaration shall become void should any alterations be made to the products without our express approval.

Manufacturer COSMO GMBH Brandstücken 31 22549 Hamburg	
	Hermann – Josef Lüken Managing Director

13 Warranty, availability guarantee, imprint



1st edition August 2020

Subject to errors and alterations.

All specifications relating to images, products, dimensions and designs are correct at the time of printing.

Subject to technical changes and changes to the colour or shape of the illustrated products.

Deviations in terms of colour cannot be ruled out due to technical reasons in the printing process.

Claims relating to the model and product cannot be asserted.

Within the framework of the current legal provisions of the Purchase Contract Law (BGB [Civil Code] with respect to warranty claims), COSMO has a limitation period of 5 years from the date of delivery.



COSMO GMBH
Brandstücken 31 · 22549 Hamburg

info@cosmo-info.de
www.cosmo-info.de

EN

COSMO
GUTES KLIMA
BESSER LEBEN

ASSEMBLY AND OPERATING CONSTRUCTIONS

CFWME / CFWMEXL



SAFETY ADVICE

Safety advice

Please pay attention to the following safety advice in order to avoid danger and damage to people and property.

Danger of electric shock:

- When carrying out works, the device must first of all be disconnected from the mains.
- It must be possible to disconnect the device from the mains at any time.
- Do not use the device if it is visibly damaged.

Instructions

Attention must be paid to the valid local standards, regulations and directives!

Information about the product

Proper usage

The controller is designed for use in DHW heat exchange modules in compliance with the technical data specified in this manual.

Improper use excludes all liability claims.

EU Declaration of conformity

The product complies with the relevant directives and is therefore labelled with the CE mark. The Declaration of Conformity is available upon request, please contact the manufacturer.



NOTE

Strong electromagnetic fields can impair the function of the device.

- Make sure the device as well as the system are not exposed to strong electromagnetic fields.

Target group

These instructions are exclusively addressed to authorised skilled personnel.

Only qualified electricians are allowed to carry out electrical works.

Initial commissioning must be effected by authorised skilled personnel.

Authorised skilled personnel are persons who have theoretical knowledge and experience with the installation, commissioning, operation, maintenance, etc. of electric/electronic devices and hydraulic systems and who have knowledge of relevant standards and directives.

Disposal

Dispose of the packaging in an environmentally sound manner.

Dispose of old appliances in an environmentally sound manner. Upon request we will take back your old appliances bought from us and guarantee an environmentally sound disposal of the devices.

Description of symbols

Warnings are indicated with a warning symbol!

Signal words describe the danger that may occur, when it is not avoided.

WARNING means that injury, possibly life-threatening injury, can occur.



→ It is indicated how to avoid the danger described.

ATTENTION means that damage to the appliance can occur.



→ It is indicated how to avoid the danger described.



NOTE

Notes are indicated with an information symbol.

→ Arrows indicate instruction steps that should be carried out.

Subject to technical change. Errors excepted.

Contents

Safety advice	44
Technical data and overview of functions....	45
1. Installation	46
1.1 Mounting.....	46
1.2 Electrical connection.....	46
Data communication / Bus	47
MicroSD card slot.....	47
2. Overview of relay and sensor allocation.....	48
3. Operation and function.....	50
4. Commissioning.....	57
Commissioning the single station	57
Commissioning the cascade	60
5. Main menu.....	63
Main menu Single station	63
Main menu Station 1	63
Menu structure.....	64
6. Status.....	65
Status / Overview Single station.....	65
Status / Overview Cascade.....	66
Hot water	66
Cascade*	66
Circulation.....	66
Disinfection.....	66
Stratified return.....	66
Error relay	67
Messages.....	67
Device info.....	67
7. Hot water	68
Set hot water temperature	68
Sliding set value.....	68
Comfort.....	69
Emergency operation.....	69
8. Cascade	70
Circulation.....	71
9. Optional functions.....	71
Circulation pump offset	72
Disinfection.....	73
Stratified return.....	74
Blocking protection	75
Error relay	75
10. Basic settings.....	76
11. SD card.....	77
12. User code	78
13. Manual mode	79
14. Troubleshooting.....	80
15. Index	82
16. EU Declaration of conformity.....	83
17. Guarantee, warranty, availability guarantee, imprint.....	87

TECHNICAL DATA AND OVERVIEW OF FUNCTIONS

- Customised control for systems with or without circulation
- Flexible circulation function for different user profiles, also available with thermal disinfection
- Control of PWM pumps
- Commissioning menu for easy configuration
- Clear system graphic in the status menu
- Cascades of up to 4 DHW exchange controllers or stations

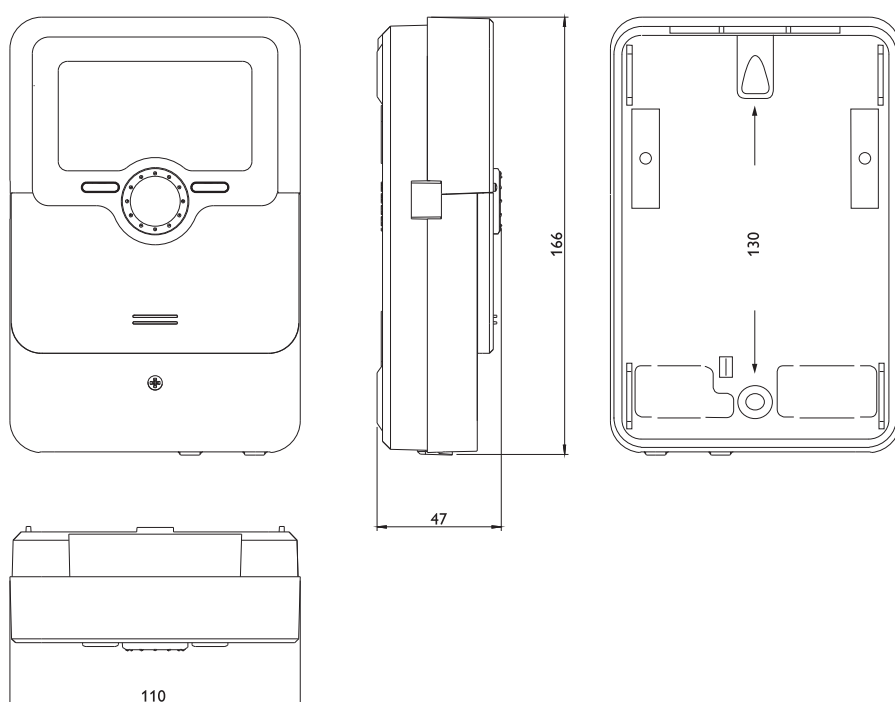

Technical data

Inputs:

4 Pt1000 temperature sensors,
1 flow rate sensor (0-500 Hz interface)

Outputs:

3 semiconductor relays, 2 PWM outputs,
1 potential-free extra-low voltage relay

Switching capacity:

1 (1) A 240 V~ (semiconductor relay)

1 (1) A 30 V=== (potential-free extra-low
voltage relay)

Total switching capacity:

4 A 240 V~

Power supply:

100 – 240 V~ (50 – 60 Hz)

Supply connection:

type Y attachment

Mode of operation:

type 1.B.C.Y action

Rated impulse voltage:

2,5 kV

Data interface:

VBus®, cascade bus, MicroSD card slot

VBus® current supply:

60 mA

Housing:

plastic, PC-ABS and PMMAA

Mounting:

wall mounting, also suitable for mounting into
patch panels

Indication/Display:

graphic display, operating control LED
(Lightwheel®)

Operation:

4 push buttons and 1 adjustment dial
(Lightwheel®)

Protection type: IP 20 / DIN EN 60529

Protection class: I

Ambient temperature: 0 ... 40°C

Degree of pollution: 2

Dimensions: 110 x 166 x 47 mm

1. INSTALLATION

1.1 Mounting

WARNING! ELECTRIC SHOCK!



Upon opening the housing, live parts are exposed!

→ **Always disconnect the device from power supply before opening the housing!**



NOTE:

Strong electromagnetic fields can impair the function of the device.

→ Make sure the device as well as the system are not exposed to strong electromagnetic fields.

Normally, the CFWME DHW exchange controller is integrated in a DHW exchange module. The unit must only be located in dry interior rooms.

1.2 Electrical connection

WARNING! ELECTRIC SHOCK!



Upon opening the housing, live parts are exposed!

→ **Always disconnect the device from power supply before opening the housing!**

ATTENTION! ESD DAMAGE!



Electrostatic discharge can lead to damage to electronic components!

→ **Take care to discharge properly before touching the inside of the device! To do so, touch a grounded surface such as a radiator or tap!**



NOTE:

Connecting the device to the power supply must always be the last step of the installation!



NOTE:

It must be possible to disconnect the device from the mains at any time.

→ Install the mains plug so that it is accessible at any time.

→ If this is not possible, install a switch that can be accessed.

If the mains cable is damaged, it must be replaced by a special connection cable which is available from the manufacturer or its customer service.

Do not use the device if it is visibly damaged!

The controller is equipped with 4 relays in total to which loads such as pumps, valves, etc. can be connected:

- Relays 1 ... 3 are semiconductor relays, designed for pump speed control:
 - Conductor R1 ... R3
 - Neutral conductor N
 - Protective earth conductor \oplus
- Relay 4 is a potential-free low voltage relay



NOTE:

The pump speed must be set to 100% when auxiliary relays or valves are connected.



NOTE:

The cables of the controller are pre-connected. cap. 1.2 is for information purposes only. Make sure the hydraulic system is properly grounded!

Depending on the product version, mains cables and sensor cables are already connected to the device. If that is not the case, please proceed as follows:

Temperature sensors have to be connected to the terminals S1 to S4 (either polarity).

Connect the flow rate sensor to the terminals **T** and **V** with correct polarity.

The terminals marked **PWM** are control outputs for a high-efficiency pump.

1. INSTALLATION

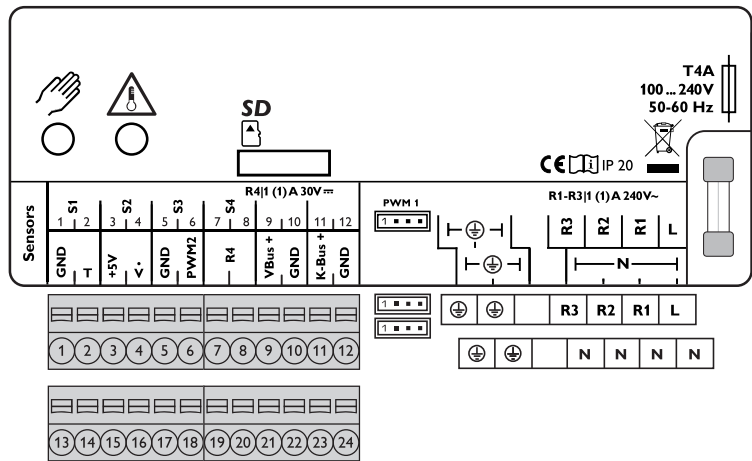

NOTE:

Connect the permanent phase of the line valve along with the power supply of the controller to L. Connect the switching phase of the line valve to R3.

The controller is supplied with power via a mains cable. The power supply of the device must be 100 ... 240 V~ (50 ... 60 Hz).

The **mains connection** is at the terminals:

Neutral conductor	N
Conductor	L
Protective earth conductor	⊕



NOTE:

For more details about the commissioning procedure see page 57.

Data communication / Bus

The controller is equipped with the **VBus® (21/22)** for data transfer with and energy supply to external modules. The connection is to be carried out at the terminals marked **VBus** (any polarity). One or more VBus® modules can be connected via this data bus, such as:

- Alarmmodul AM1
- Datalogger

If a **cascade** is installed, the following section is valid additionally:

All cascade controllers are equipped with a cascade bus for data communication with each other. The connection is to be carried out at the terminals marked **K-Bus (23/24)** with correct polarity.

MicroSD card slot

The controller is equipped with a MicroSD card slot.

With a MicroSD card, the following functions can be carried out:

- ➔ Store measurement and balance values onto the MicroSD card. After the transfer to a computer, the values can be opened and visualised, e. g. in a spreadsheet.
- ➔ Prepare adjustments and parameterisations on a computer and transfer them via the MicroSD card.
- ➔ Store adjustments and parameterisations on the MicroSD card and, if necessary, retrieve them from there.
- ➔ Download firmware updates from the Internet and install them on the controller via MicroSD card.

A MicroSD card is not included.

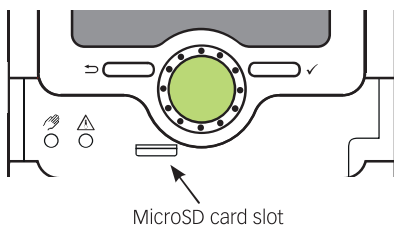

MicroSD card slot



NOTE:

For more information about using a MicroSD card, see page 77.

2. OVERVIEW OF RELAY AND SENSOR ALLOCATION

Single station CFWME

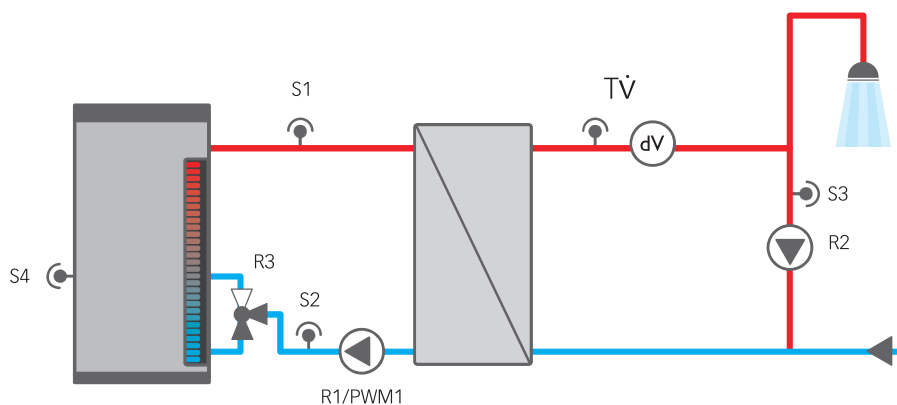

Single station CFWEXL

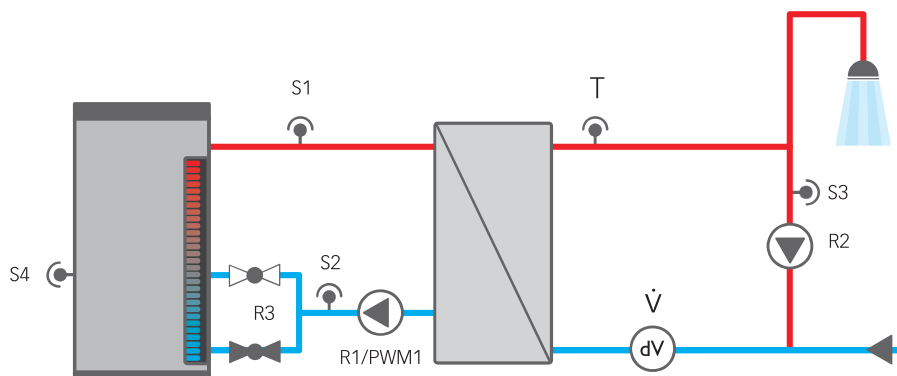

Connection terminal	Single station
S1 (1 / 2)	Flow primary circuit
S2 (3 / 4) (optional)	Stratified return source
S3 (5 / 6) (optional)	Circulation
S4 (7 / 8) (optional)	Stratified return store
T	DHW
\dot{V}	DHW
R4 (19 / 20) (optional)	Error relay
VBus (21 / 22)	Visualisation
K-Bus (23 / 24)	not used
PWM1 (Connector)	Speed primary pump
R3 (optional)	Stratified return
R2 (optional)	Circulation
R1	Primary pump

2. OVERVIEW OF RELAY AND SENSOR ALLOCATION

Cascade CFWME (CFWMEXL not shown)

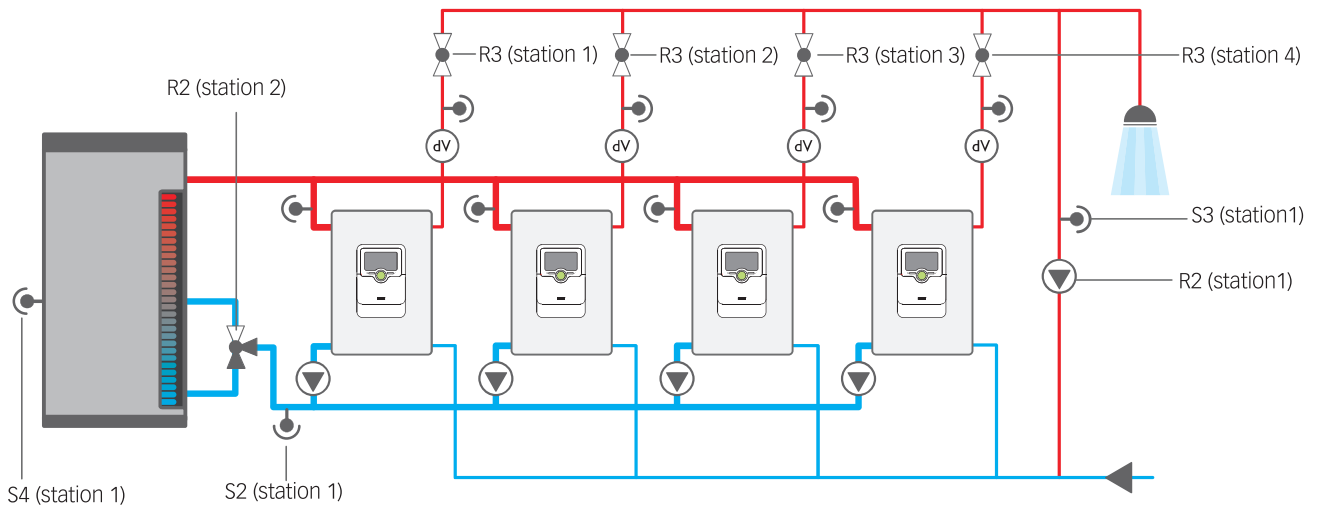

Connection terminal	Station 1	Station 2	Station 3 / 4
S1 (1 / 2)	Flow primary circuit	Flow primary circuit	Flow primary circuit
S2 (3 / 4) (optional)	Stratified return source	-	-
S3 (5 / 6) (optional)	Circulation	-	-
S4 (7 / 8) (optional)	Stratified return store	-	-
T	DHW	DHW	DHW
\dot{V}	DHW	DHW	DHW
R4 (19 / 20) (optional)	Error relay	-	-
VBus (21 / 22)	Visualisation	-	-
K-Bus (23 / 24)	Cascade bus	Cascade bus	Cascade bus
PWM1 (Connector)	Speed primary pump	Speed primary pump	Speed primary pump
R3	Line valve	Line valve	Line valve
R2 (optional)	Circulation	Stratified return	-
R1	Primary pump	Primärpumpe	Primärpumpe

3. OPERATION AND FUNCTION

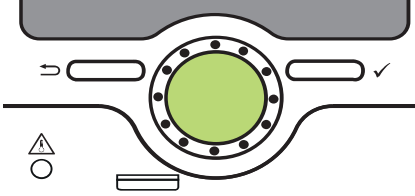

Buttons and adjustment dial

The controller is operated via 2 buttons and 1 adjustment dial (Lightwheel®) below the display:



Left button (←) - escape button for changing into the previous menu

Right button (✓) - confirming / selecting

Lightwheel® - scrolling upwards / scrolling downwards, increasing adjustment values / reducing adjustment values

Microbuttons for manual mode and emergency operation



The controller is equipped with 2 microbuttons for quick access to the emergency operation and the manual mode. The microbuttons are located underneath the slidable housing cover, the slider.

Microbutton : If the microbutton  is briefly pressed, the controller changes to the manual mode menu (see page 79).

Microbutton : The microbutton  is used for activating the emergency operation (see page 69).

Operating control LED

The controller is equipped with a multicolour control LED in the centre of the Lightwheel®, indicating the following states:

Colour	Permanently shown	Flashing
	Everything OK	A note exists, see page 67.
		Disturbance or warning exists (see page 67), error relay active, manual mode active
	Parameterisation active	Storage active

Parameterisation mode

After the installer code is entered (see page 78), the controller changes to the parameterisation mode.



NOTE:

In parameterisation mode, the control process will stop and the message **Control stopped - Parameterisation active** be indicated.

The LED in the Lightwheel® will glow yellow.

→ In order to carry out adjustments in the menu, press the right button (✓).

The controller changes to the main menu in which adjustments on the installer level can be made.

→ In order to save the adjustments made, press the microbutton  for approx. 3s or select the menu item **Save** in the main menu.

→ In order to cancel the parameterisation process and to discard adjustments made, press the left button (←) for approx. 3s.

The controller will leave the installer level and restart.

3. OPERATION AND FUNCTION

Selecting menu points and adjusting values

During normal operation of the controller, the display is in the main menu.

If no button is pressed for 2 min, the display switches to standby mode. After further 10s, the display illumination switches off.

In order to get from the Status menu into the Main menu, press the left button (←).

Press any key to reactivate the display illumination. In order to scroll through the menu items, turn the Lightwheel®.

Values and options can be changed in different ways:

Numeric values can be adjusted by means of a slide bar. The minimum value is indicated to the left, the maximum value to the right. The large number above the slide bar indicates the current adjustment. By turning the Lightwheel®, the upper slide bar can be moved to the left or to the right.

Only after the adjustment has been confirmed by pressing the right button (✓) will the number below the slide bar indicate the new value. The new value will be saved if it is confirmed by pressing the right button (✓) again.

When 2 values are locked against each other, they will display a reduced adjustment range depending on the adjustment of the respective other value.

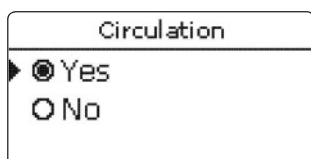
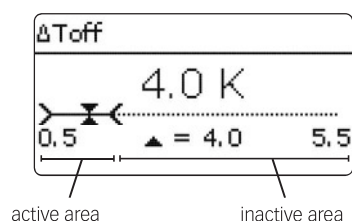

In this case, the active area of the slide bar is shortened, the inactive area is indicated as a dotted line. The indication of the minimum and maximum values will adapt to the reduction.

If only one item of several can be selected, they will be indicated with „radio buttons“. When one item has been selected, the radio button in front of it is filled.

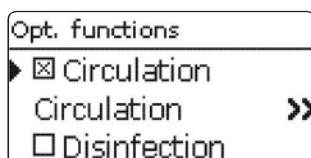

If more than one item of several can be selected, they will be indicated with checkboxes. When an item has been selected, an **x** appears inside the checkbox.

3. OPERATION AND FUNCTION

Timer
▶ Day selection
Reset
back

Day selection
<input checked="" type="checkbox"/> Mon
<input type="checkbox"/> Tue
<input checked="" type="checkbox"/> Wed
<input type="checkbox"/> Thu
<input type="checkbox"/> Fri
<input type="checkbox"/> Sat
<input checked="" type="checkbox"/> Sun
▶ Continue

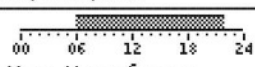
Mon, Wed, Sun

▶ New time frame
Copy from

Mon, Wed, Sun
▶ Start --:--
Stop --:--
back

Start
06:00

Stop
08:30

Adjusting the timer

With the **Timer** time frames for the function can be adjusted.

In the **Day selection** channel, the days of the week are available.

If several days are selected, they will be merged into one combination for the following steps.

The last menu item after the list of days is **Continue**. If **Continue** is selected, the timer menu opens, in which the time frames can be adjusted.

Adding a time frame:

In order to add a time frame, proceed as follows:

→ **Select New time frame.**

→ Adjust **Start and Stop** for the desired time frame. The time frames can be adjusted in steps of 10 min.

3. OPERATION AND FUNCTION

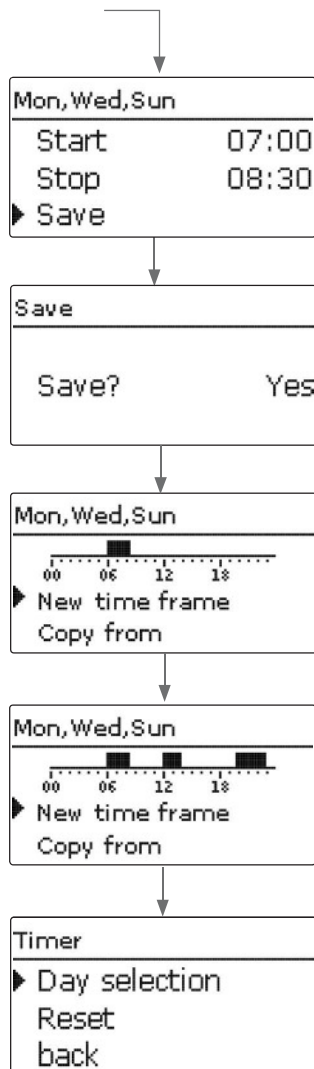

→ In order to save the time frame, select **Save** and confirm the security enquiry with **Yes**.

→ In order to add another time frame, repeat the previous steps.
6 time frames can be adjusted per day or combination.

→ Press the left button (←) in order to get back to the day selection.

3. OPERATION AND FUNCTION

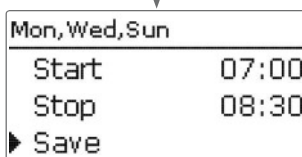
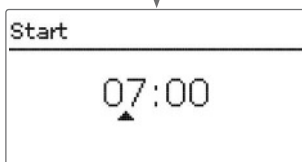
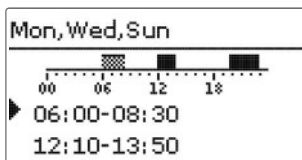
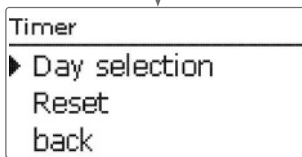
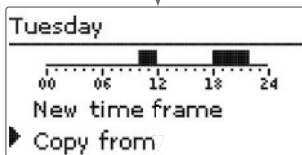
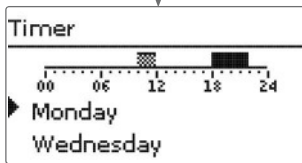
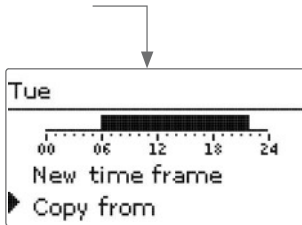

Copying a time frame:

In order to copy time frames already adjusted into another day / other days, proceed as follows:

- ➔ Choose the days(s) into which the time frames are to be copied and select **Copy from**.

A selection of days with time frames will appear.

- ➔ Select the day from which the time frames are to be copied.

All time frames adjusted for the selected day will be copied. Existing time frames will be overwritten.

Changing a time frame:

In order to change a time frame, proceed as follows:

- ➔ Select the time frame to be changed.
- ➔ Make the desired change.

- ➔ In order to save the time frame, select **Save** and confirm the security enquiry with **Yes**.

3. OPERATION AND FUNCTION

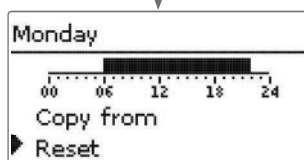
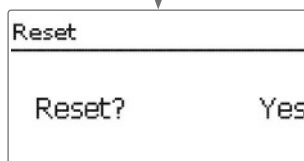
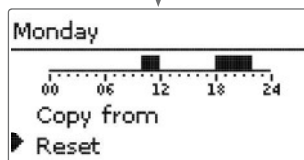
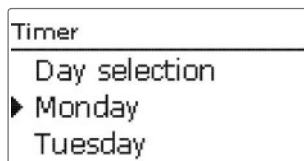
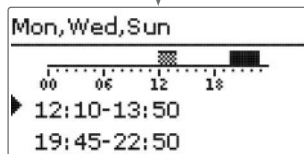
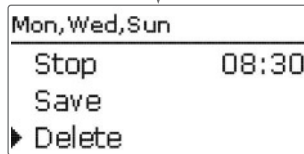
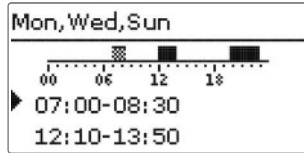

Removing a time frame:

In order to delete a time frame, proceed as follows:

→ Select the time frame that is to be deleted.

→ Select **Delete** and confirm the security enquiry with **Yes**.

Resetting the timer:

In order to reset time frames adjusted for a certain day, proceed as follows:

→ Select the desired day.

→ Select **Reset** and confirm the security enquiry with **Yes**.

3. OPERATION AND FUNCTION

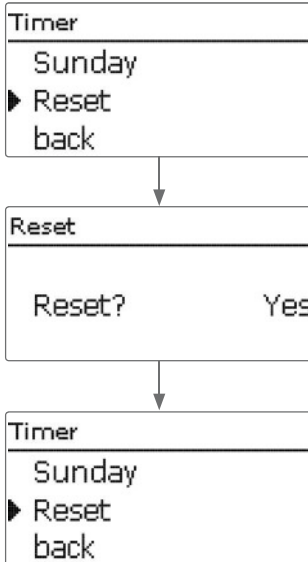

In order to reset the whole timer, proceed as follows:

→ Select **Reset** and confirm the security enquiry with **Yes**.

All adjustments made for the timer are deleted.

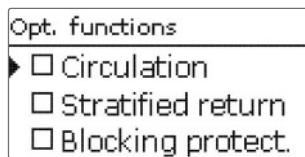

Adjusting optional functions

In the **Optional functions** menu, optional functions can be selected and adjusted.

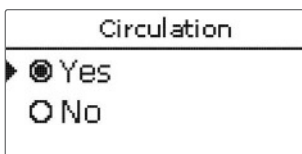

In order to activate a function, select the desired function and confirm the enquiry with **Yes**.

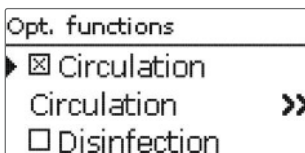

When a function has been activated, an **x** within the checkbox and a new menu line with the symbol **>>** appear. When this menu item is selected, a submenu opens in which all adjustments required can be made.

In order to save the adjustments, select **Save** in the main menu or press and hold down the micro button  for approx. 3s..

In order to delete a function, select the function in the **Optional functions** menu and answer the enquiry with **No**.

4. COMMISSIONING

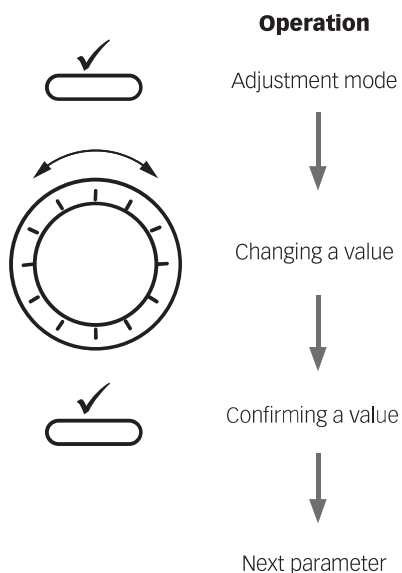

When the hydraulic system is filled and ready for operation, connect the controller to the mains. The controller runs an initialisation phase in which the Lightwheel® glows green.

When the controller is commissioned or when it is reset, it will run a commissioning menu after the initialisation phase. The commissioning menu leads the user through the most important adjustment channels needed for operating the system.

Commissioning menu

The commissioning menu consists of the channels described in the following. In order to make an adjustment, adjust the desired value with the Lightwheel® and confirm with the right button (✓). The next channel will appear in the display.

Commissioning the single station

1. Language:

→ Adjust the desired menu language.

2. System type:

→ Select the system type **single station**.

3. Daylight savings time adjustment:

→ Activate or deactivate the automatic daylight savings time adjustment.

4. Time:

→ Adjust the clock time. First of all adjust the hours, then the minutes.

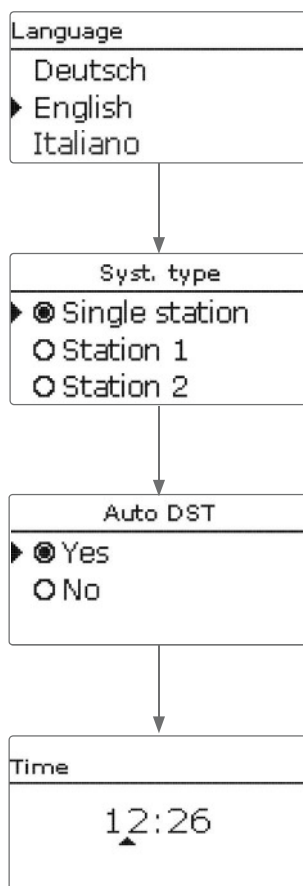

4. COMMISSIONING

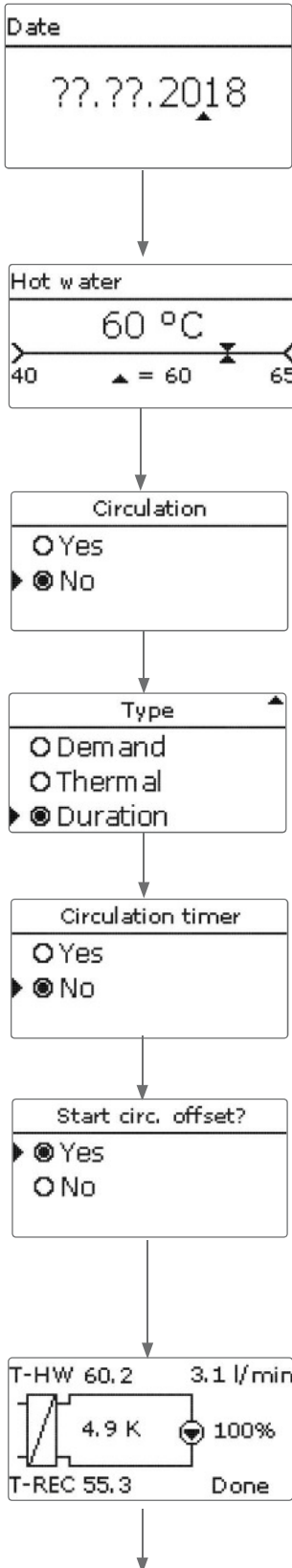

5. Date:

→ Adjust the date. First of all adjust the year, then the month and then the day.

6. Set hot water temperature:

Adjust the desired set hot water temperature. For further information, see page 68.

7. Circulation:

→ Activate or deactivate the circulation.

If the circulation is activated, further channels appear:

→ Select the circulation type.



NOTE

For all circulation types, the circulation sensor S3 is required.

→ Activate or deactivate the circulation timer.

For more information about circulation, see page 66.



NOTE

No draw-off may be carried out during the offset. All ball valves of the station must be fully opened (normal position).

→ Start the offset.

The current temperature difference between the hot water sensor and the return sensor is indicated as ΔT pipe.



NOTE:

For hot water hygiene, the circulation return temperature should be max. 5 K below the hot water temperature. E.g. hot water = 60 °C, circulation > 55 °C

→ Adjust the speed at the circulation pump.

→ If the desired temperature difference is reached, confirm the offset with the right button (✓).

4. COMMISSIONING

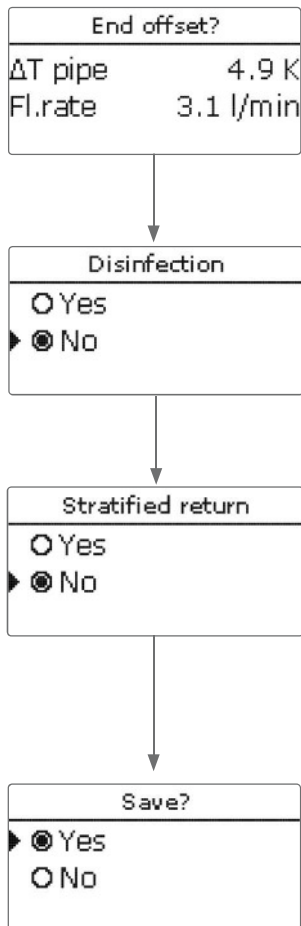

→ Complete the offset by pressing the right button (✓).

For more information about the offset, see page 71.

8. Disinfection:

→ Activate or deactivate the disinfection.

For more information about the Disinfection see page 73.

9. Stratified return:

→ Activate or deactivate the stratified return.

For more information about the Stratified return see page 74.



NOTE

For the stratified return function, the sensors stratified return source S2 and stratified return store S4 are required.

10. Completing the commissioning menu:

→ In order to save the adjustments, select the menu item **Save**. The controller is then ready for operation and normally the factory settings will give close to optimum operation of the system.



NOTE

The adjustments carried out during commissioning can be changed anytime in the corresponding adjustment channel. Additional functions and options can also be activated and adjusted.

Set the code to the customer code before handing over the controller to the customer (see page 78)

4. COMMISSIONING

COMMISSIONING THE CASCADE

Station 1 is the cascade master, stations 2 to 4 are cascade slaves. The commissioning menu has to be run on each controller, beginning with the cascade master (station 1). The adjustments made at station 1 will be adopted by the other stations automatically.

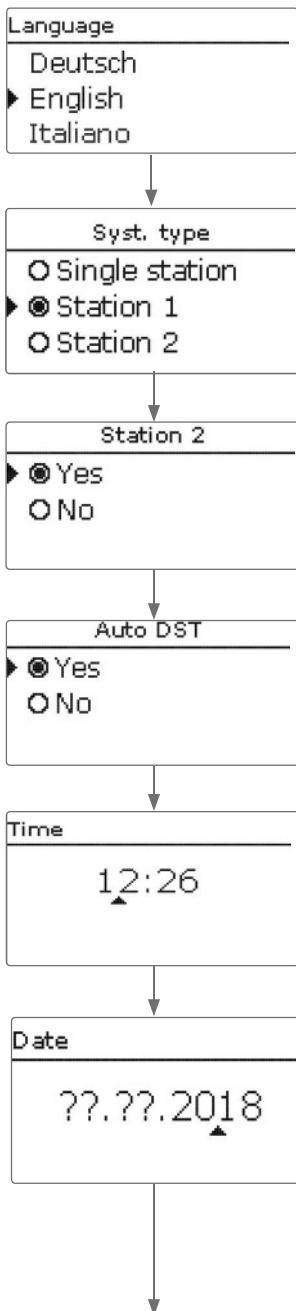

CASCADE MASTER

1. Language:

→ Adjust the desired menu language.

2. System type:

→ Adjust the system type **Station 1**.

→ Activate or deactivate further stations of the cascade.

3. Daylight savings time adjustment:

→ Activate or deactivate the automatic daylight savings time adjustment.

4. Time:

→ Adjust the clock time. First of all adjust the hours, then the minutes.

5. Date:

→ Adjust the date. First of all adjust the year, then the month and then the day.

4. COMMISSIONING

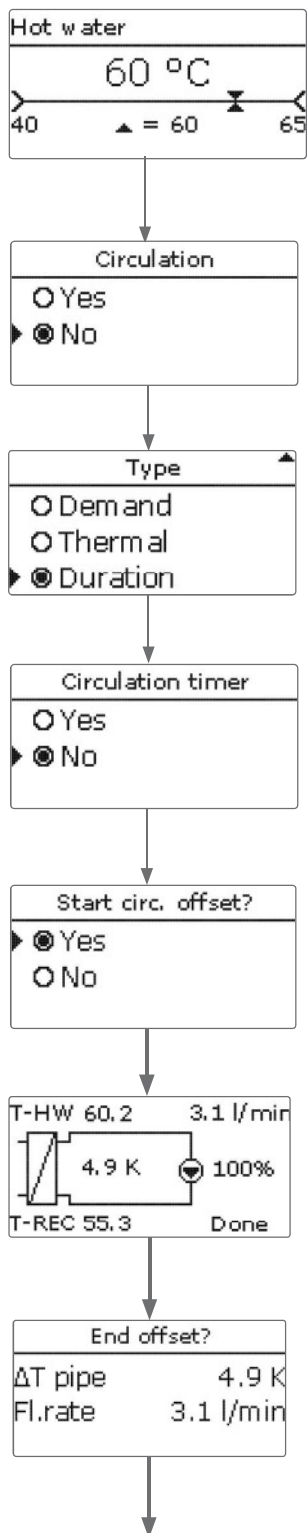

6. Set hot water temperature:

- Adjust the desired set hot water temperature.
- For further information, see page 68.

7. Circulation:

- Activate or deactivate the circulation.

If the circulation is activated, further channels appear:

- Select the circulation type.



NOTE

For all circulation types, the circulation sensor S3 is required.

- Activate or deactivate the circulation timer.

For more information about circulation, see page 71.



NOTE

No draw-off may be carried out during the offset. All ball valves of the station must be fully opened (normal position).

- Start the offset.

The current temperature difference between the hot water sensor and the return sensor is indicated as **ΔT pipe**.



NOTE:

For hot water hygiene, the circulation return temperature should be max. 5 K below the hot water temperature. E.g. hot water = 60 °C, circulation >55 °C

- Adjust the speed at the circulation pump.
- If the desired temperature difference is reached, confirm the offset with the right button (✓).

- Complete the offset by pressing the right button (✓).

For more information about the offset, see page 71.

4. COMMISSIONING

Disinfection
<input type="radio"/> Yes <input checked="" type="radio"/> No

Stratified return
<input type="radio"/> Yes <input checked="" type="radio"/> No

Save?
<input checked="" type="radio"/> Yes <input type="radio"/> No

Language
<input type="radio"/> Deutsch <input checked="" type="radio"/> English <input type="radio"/> Italiano

Type
<input type="radio"/> Single station <input type="radio"/> Station 1 <input checked="" type="radio"/> Station 2

Save?
<input checked="" type="radio"/> Yes <input type="radio"/> No

8. Disinfection:

→ Activate or deactivate the disinfection.

For more information about the Disinfection see page 73.

9. Stratified return:

→ Activate or deactivate the stratified return.

For more information about the stratified return see page 74.



NOTE

For the stratified return function, the sensors stratified return source S2 and stratified return store S4 are required.

10. Completing the commissioning menu:

→ In order to save the adjustments, select the menu item **Save**. The controller is then ready for operation and normally the factory settings will give close to optimum operation of the system.

CASCADE SLAVES

1. Language:

→ Adjust the desired menu language.

2. System type:

→ Adjust the system type **Station 2**.

→ Activate or deactivate further stations of the cascade.

3. Completing the commissioning menu:

→ In order to save the adjustments, select the menu item **Save**. The controller is then ready for operation and normally the factory settings will give close to optimum operation of the system.

→ If further stations of the cascade have been activated, run the commissioning menu of the corresponding stations (**Station 3 ... 4**).



NOTE

The adjustments carried out during commissioning can be changed anytime in the corresponding adjustment channel. Additional functions and options can also be activated and adjusted.

Set the code to the customer code before handing over the controller to the customer (see page 78).

5. MAIN MENU

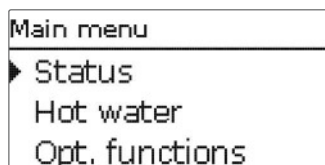

Main menu Single station

In this menu, different menu areas can be selected.

The following menus are available:

Status
Hot water
Optional functions
Basic setting
SD card
User code
Manual mode



NOTE:

If no button is pressed for 2 min, the display switches to standby mode. After further 10s the display illumination switches off.

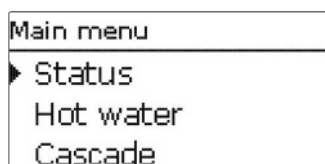

Main menu Station 1

In this menu, different menu areas can be selected.

The following menus are available in cascade operation:

Status
Hot water
Cascade*
Optional functions
Basic setting
SD card
User code
Manual mode

In cascade operation, all adjustments have to be carried out at the cascade master (station 1). Stations 2 to 4 are cascade slaves and receive all information from the cascade master on which all important adjustments have to be made. The menus are available for the slaves in an shortened form.

*Available for System type Station 1 only

5. MAIN MENU

Menu structure

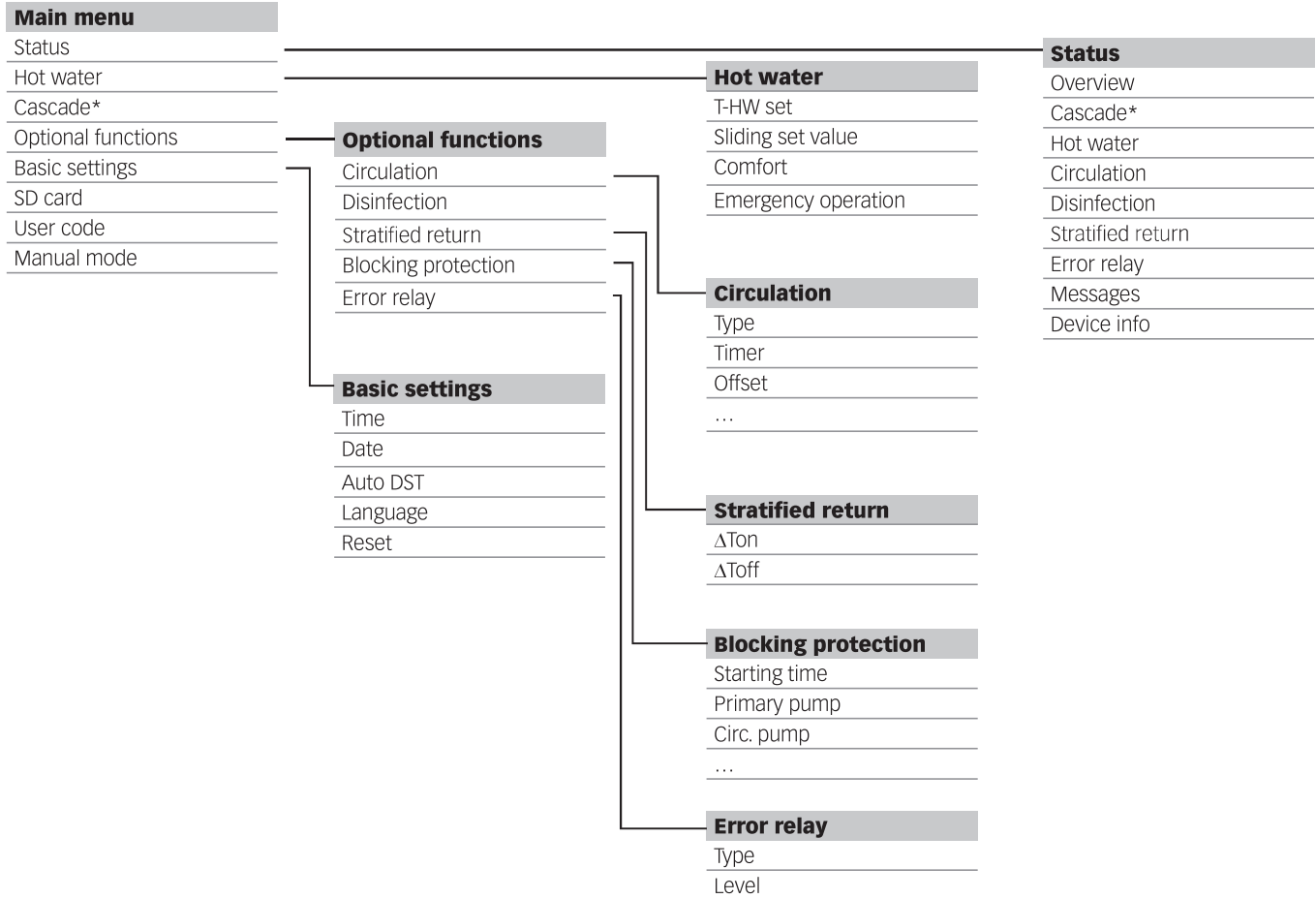

The menu items and adjustment values selectable are variable depending on adjustments already made. The figure only shows an exemplary excerpt of the complete menu in order to visualise the menu structure.

* Available for System type Station 1 only

6. STATUS

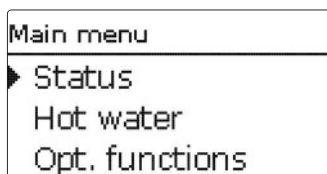

In the status menu of the controller, the status messages for every menu area can be found.

Overview of displayed values

Display	Description
T-store	Store temperature stratified return
Base / Centre	Position of the valve stratified return
T-RE	Return temperature primary circuit stratified return
T-REC	Return temperature circulation
T-FL	Flow temperature primary circuit
T-HW	Hot water temperature
T-HW set	Set hot water temperature
Fl.rate	Flow rate hot water
Primary p.	Speed primary pump
Circ. pump	Speed circulation pump
Valve	Valve stratified return

Status / Overview Single station

In the **Status / Overview menu**, all current measured values are indicated in a clear system graphic. Depending on the adjustments already made, the system graphic consists of up to 3 parts:

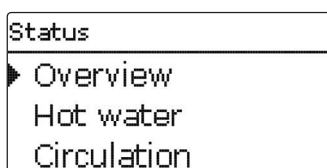

The first part shows the primary circuit with the corresponding values.

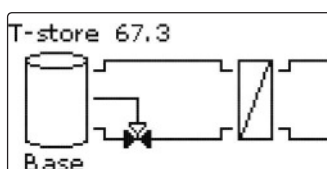

The second part shows the heat exchanger and the third part the secondary circuit with the corresponding values.

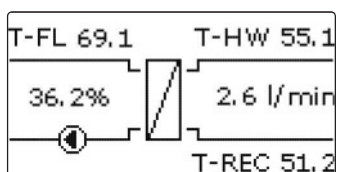

In order to scroll through the parts, turn the Lightwheel® clockwise.

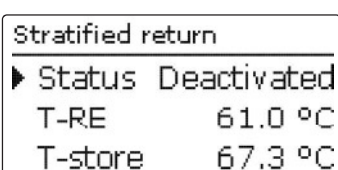
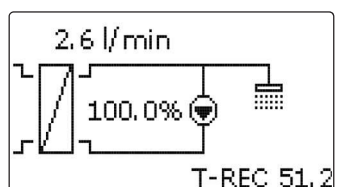

The information given in the system graphic can also be indicated as a text. For this purpose, select the desired part and press the right button (✓). In order to get back to the graphic, press the left button (←).

6. STATUS

Status
► Overview
Cascade
Hot water

T-FL 69.1	T-HW 60.0
2.3 l/min	

T-FL 69.1	T-HW 60.0
14.0%	4.3 l/min
	Open

Cascade
► Basic load Station 1
T-FL 69.1 °C
T-HW 60.2 °C

Hot water
► Status Active
T-HW set 60 °C
T-FL 69.1 °C

Cascade
► Basic load Station 1
T-FL 69.1 °C
T-HW 60.0 °C

Circulation
► Status Active
T-REC 55.1 °C
Fl.rate 3.1 l/min

Disinfection
► Status Inactive
back

Stratified return
► Status Deactivated
T-RE 61.0 °C
T-store 67.3 °C

Status / Overview Cascade

In the **Status / Overview** menu, all current measured values of the stations are indicated in a clear system graphic.

In order to show the values of the corresponding station, turn the Lightwheel® clockwise.

The information of the corresponding station can also be indicated as a text. For this purpose, press the right button (✓). In order to get back to the graphic, press the left button (←).

Hot water

The **Status / Hot water** menu indicates the status of the DHW heating.

Cascade* (* Available for System type **Station 1** only)

The **Status / Cascade** menu indicates different status information of the cascade.

The overview indicates the highest temperatures of the cascade as well as the overall flow rate. In order to show the values of the individual stations, turn the Lightwheel® clockwise and select the desired station.

Circulation

The **Status / Circulation** menu indicates status information of the function.

Disinfection

The **Status / Disinfection** menu indicates status information of the function.

Stratified return

The **Status / Stratified return** menu indicates status information of the function.

6. STATUS

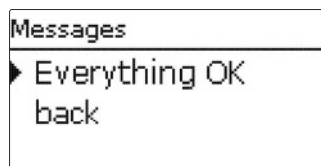
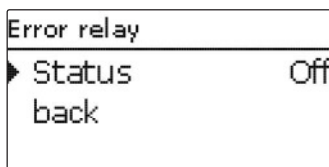

Error relay

The **Status / Error relay** menu indicates if the potential-free error relay is active or inactive.

Messages

In the **Status/Messages** menu, error and warning messages are indicated.

During normal operation, the message **Everything OK** is indicated.

A line break or short circuit in a sensor line is indicated as **!Sensor fault**. In the case of an error, the LED of the Lighthweel® flashes red in addition.

Messages are divided into Notes, Disturbances and Warnings. A **Note** is for information purposes only. In the case of a **Disturbance**, the corresponding function or station fails. In the case of a **Warning**, station 1 indicates an error because of a station failure.

Message	Category	Cause / description
!Blocking protect.	Note	Blocking protection for an output active
!Manual mode	Note	At least one relay in manual operation
!Casc. config.	Note	Incorrect cascade configuration
!Control stopped	Note	Parameterisation mode active
!Controller variant	Note	Different station variants available
!T-FL too low	Note	Flow temperature too low
!Date/Time	Fault condition	Real time clock defective
!T-RE	Fault condition	
!T-REC	Fault condition	Sensor fault (line break, short circuit or no sensor available)
!T-store	Disturbance	
!T-FL	Disturbance	
!T-HW	Disturbance	
!Valve open	Disturbance	Flow at the station detected, although there should be none
Disinfection	Warning	No return sensor circulation available
!Single controller	Warning	Incorrect cascade configuration
Stratified return	Warning	Failure Station 2
!Software update	Warning	Different software variants used in the cascade
!Timeout Station 1 ... 4	Warning	No VBus® signal available, station failure
!Valve closed	Warning	No flow at the station
!HW emerg. op.	Warning	Emergency operation active
!Circ. offset	Warning	Circulation offset has not been completed
!Circulation pump	Warning	No flow rate measured, although the circulation pump is running

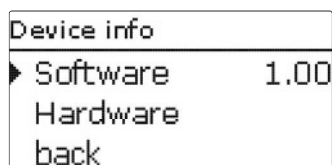

Device info

The **Status / Device** info menu indicates information about soft- and hardware.

7. HOT WATER

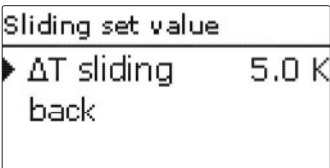
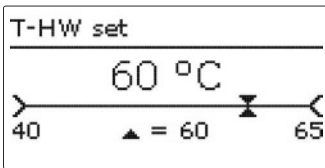
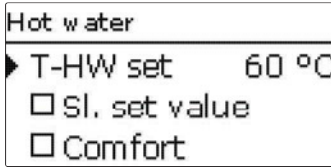

In this menu, all adjustments for the DHW heating can be made. The following parameters and functions are available:

- Set hot water temperature
- Sliding set value
- Comfort mode
- Emergency operation

Set hot water temperature

Main menu / Hot water / T-HW set

Adjustment channel	Description	Adjustment range / selection	Factory setting
T-HW set	Set hot water temperature	40...65 °C	60 °C

This parameter can be used for adjusting the **Set hot water temperature** which is to be reached at the hot water sensor. The controller then controls the speed of the primary pump so that the temperature at the hot water sensor in the secondary circuit continuously keeps the required set hot water temperature.

Sliding set value

Main menu / Hot water / Sliding set value

Adjustment channel	Description	Adjustment range / selection	Factory setting
Sliding set value	Activation of the function	Yes, No	No
ΔT sliding	Temperature difference	2,0 ... 20,0 K	5,0 K

back

If the temperature measured at the flow sensor is not sufficient for reaching the set hot water temperature, the set temperature will be decreased dynamically. The speed of the primary pump will be controlled so that the dynamic set temperature is maintained at the hot water sensor.



NOTE:

This function is only available, if the system type **Single station** has been selected.

7. HOT WATER

Comfort	
▶ Set temp.	50 °C
Hysteresis	2 K
Speed	25%

Comfort

Main menu / Hot water / Comfort

Adjustment channel	Description	Adjustment range / selection	Factory setting
Comfort	Comfort function for the plate heat exchanger	Yes, No	No
Set temp.	Indication of the set temperature of the plate heat exchanger	-	-
Hysteresis	Hysteresis when the set comfort temperature is exceeded	1 ... 10 K	2 K
Speed	Primary pump speed when the comfort mode is active	15 ... 100 %	25 %
Wait. time	Blocking time for the function after having been active	0 ... 60 min	10 min
Timer	Timer	-	-

back

The **Comfort** function can be used for preheating the plate heat exchanger in order to ensure a quick DHW supply.

In the case of a draw-off, the set hot water temperature can thus be reached more quickly at the hot water sensor.

If the comfort function is active, the primary pump switches on in order to keep the plate heat exchanger permanently at the **Set temperature**. For this purpose, the current flow temperature at the flow sensor is measured.

As soon as the comfort function is no longer active, it will be blocked for the adjusted **Waiting time**.

With the **Timer**, time frames can be adjusted in which the comfort function is active. Outside these time frames, the comfort function will be deactivated.



NOTE:

When the comfort function is activated, the risk for plate heat exchanger calcification increases.



NOTE:

In cascade operation the comfort function is activated by default.

Emergency op.	
T-FL 69.0	T-HW 59.9
Off	84.9 l/min
	T-REC 54.9

Emergency operation

Main menu / Hot water / Emerg. op.

The **Emergency operation** can be used for ensuring the hot water supply in the case of a sensor failure. In this case, the primary pump will permanently run at the adjustable emergency speed. For this purpose, the emergency speed must be aligned with the resulting hot water temperature. The display channel **T-HW** allows this alignment directly in the emergency operation adjustment channel, as soon as the emergency operation has been activated.

➔ In order to set the emergency speed, turn the Lightwheel® and confirm the adjustment with the right button (✓).



NOTE:

If a sensor failure inhibiting DHW heating has occurred, activate the emergency operation in the Emergency operation channel.



NOTE:

In cascade operation the **emergency operation** can be activated for stations 1 to 4 individually.

8. CASCADE

Cascade	
▶ Thresh. on	90%
Thresh. off	30%
<input checked="" type="checkbox"/> Station 2	

The **Cascade** menu is only available if the **System type Station 1** has been selected.

Main menu / Cascade

Adjustment channel	Description	Adjustment range / selection	Factory setting
Thresh. on	Threshold for activating the next station of the cascade	84 ... 100%	90%
Thresh. off	Threshold for deactivating the station of the cascade that has been activated at last.	0 ... 42%	30%
Station 2	Option Station 2 in the cascade		
Station 3	Option Station 3 in the cascade		
Station 4	Option Station 4 in the cascade		
back			

The parameter **Thresh. on** is used for adjusting the percentage of the maximum flow quantity that has to be exceeded for switching on the next station. The parameter **Thresh. off** is used for adjusting the percentage of the maximum flow quantity that has to be fallen below for switching off the station activated at last. In order to prevent a further station from being switched on and off too often, reduce the value **Thresh. off**.

With the parameters **Station 1** to **Station 4** the number of stations in the cascade can be adjusted.

In cascade operation, all adjustments have to be carried out at the cascade master (station 1). Stations 2 to 4 are cascade slaves and receive all information from the cascade master on which all important adjustments have to be made. The menus are available for the slaves in an shortened form.

9. OPTIONAL FUNCTIONS

In this menu, optional functions can be selected and adjusted.

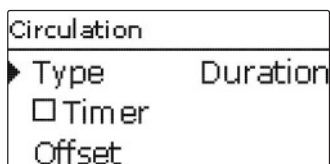

Circulation

Main menu / Opt. functions / Circulation

Adjustment channel	Description	Adjustment range / selection	Factory setting
Circulation	Activation of the function	Yes, No	No
Type	Variant	Therm+Dem., Demand, Thermal, Duration	Duration
Timer	Timer option	Yes, No	No
Ton	Switch-on temperature	10 ... 62 °C	55 °C
ΔT_{off}	Switch-off temperature difference	2 ... 10K	3K
Runtime	Circulation pump runtime	0 ... 60 min	5 min
Break time	Circulation pump break time	0 ... 60 min	5 min
Offset	Circulation pump offset	-	-
Start offset?	Starting the offset		
End offset?	Ending the offset		
ΔT pipe	Indication of the temperature drop between the hot water sensor and the return sensor	-	-
Fl.rate	Indication of the flow rate value stored	-	-
back			

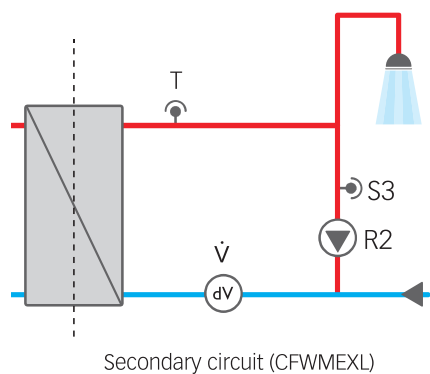
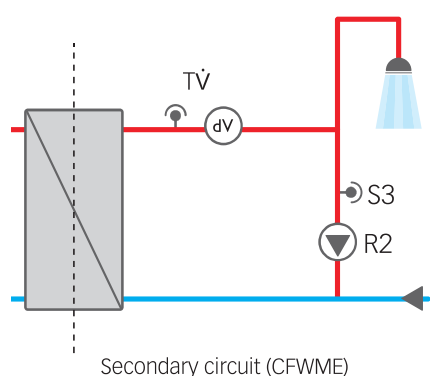

Running an offset:



NOTE:

No draw-off may be carried out during the offset. All ball valves of the station must be fully opened (normal position).

The **offset** has to be run only once, e.g. during commissioning.

→ In order to run an offset, select the parameter **Offset**, see page 72.

The Circulation function can be used for controlling a circulation pump.

For the control logic, 5 variants are available:

- Thermal + Demand
- Demand
- Thermal
- Duration
- Off



NOTE:

For all circulation types, the circulation sensor S3 is required.

9. OPTIONAL FUNCTIONS

If one of the variants is selected, the corresponding adjustment channels will appear.

Each variant has a timer by means of which time frames for the operation of the function can be adjusted. Within the adjusted time frames the variants work as follows:

Thermal

The temperature at the return sensor is monitored. The circulation pump switches on, if the temperature falls below the adjusted **Switch-on temperature**. If the temperature exceeds the **Switch-on temperature** by the **Switch-off temperature difference**, the circulation pump switches off.

Duration

The circulation pump switches on within the adjusted time frames, outside of them it switches off.

Demand

When a draw-off impulse (draw off 1-4 s) is detected at the flow rate sensor, the controller switches on the circulation pump. The circulation pump remains switched on for the adjusted **Runtime**. If the circulation pump has been running and the runtime has elapsed, each further draw-off impulse is ignored for the **Break time** and the circulation pump remains switched off.

Off

The circulation pump is switched off.

Thermal + Demand

The temperature at the return sensor is monitored. The circulation pump switches on, if the temperature falls below the adjusted **Switch-on temperature** and if a draw-off impulse (draw off 1-4 s) is detected at the flow rate sensor. The circulation remains switched on for the adjusted **Runtime**. If the **Switch-on temperature** is exceeded during this period by the **Switch-off temperature difference**, the circulation pump switches off. If the circulation pump has been running and the runtime has elapsed, each further draw-off impulse is ignored for the **Break time** and the circulation pump remains switched off.



NOTE
For information on timer adjustment see page 52.



NOTE
In cascade operation, only the types **Duration**, **Thermal** and **Off** are available.

Circulation pump offset

The temperature drop between the hot water sensor and the return sensor can be reduced by increasing the circulation pump speed. The current temperature difference between the hot water sensor and the return sensor is indicated as **ΔT pipe**.

The optimum temperature difference is approx. 5 K.

- Select the menu item **Offset**.
- In order to start the offset, select **Start offset?**
- Adjust the speed at the circulation pump.
- If the desired temperature difference is reached, confirm the offset with the right button (✓).

The **Menu End offset?** appears.

- Complete the offset by pressing the right button (✓).

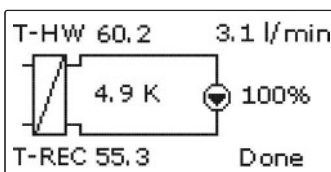

End offset?	
ΔT pipe	4.9 K
Fl.rate	3.1 l/min

9. OPTIONAL FUNCTIONS

Disinfection	
▶ Set temp.	60 °C
Runtime	60 Min
Duration	5 Min

Disinfection

Main menu / Opt. functions / Disinfection

Adjustment channel	Description	Adjustment range / selection	Factory setting
Disinfection Start?	Activation of the function Manual start of the disinfection	Yes, No	No
Set temp.	Set temperature for the disinfection	60 ... 75 °C	60 °C
Runtime	Runtime of the disinfection function	30 ... 240 min	60 Min
Duration	Duration of the disinfection	1 ... 240 min	5 Min
Hysteresis	Hysteresis for the disinfection	1 ... 5 K	5 K
Overrun Time	Overrun time of the pump Time for the automatic start of the disinfection	1 ... 60 min 01:00 ... 23:00	10 min 01:00
Monday ... Sunday	Submenu for selecting the days for the automatic start of the disinfection	Monday ... Sunday	all
back			

This function helps to contain the spread of Legionella in hot water and circulation pipes in the secondary circuit of the heat exchanger. The **Disinfection** function starts automatically, if the adjusted **Time** at the adjusted day is reached.

The function can also be started manually via the menu item **Start?**

If the disinfection starts, the circulation pump switches on.

The circulation pump remains active for the adjustable **Runtime**.

During disinfection, the speed of the primary pump is controlled so that the adjustable **Set temperature** is maintained at the hot water sensor. The progress of the disinfection is indicated in % in the status menu.

The disinfection is considered successfully completed, if during the adjusted **Runtime** the temperature at the return sensor has continuously exceeded the value **Set temperature-Hysteresis** for the entire adjusted **Duration**. The date of the last disinfection is indicated in the status menu.

After disinfection has ended, the circulation pump remains switched on for the adjusted **Overrun time**. When the **disinfection** function is active, it can be cancelled by means of the menu item **Cancel?** at any time.

WARNING!

Scald danger!



Scalding may occur if the set temperature is adjusted to a value higher than 60 °C.

→ Make sure that no water is drawn off by non-professionals during disinfection.



NOTE:

While the disinfection is active, a sufficiently high store temperature must be ensured.

→ Make sure the store is sufficiently heated before disinfection begins.



NOTE:

In cascade operation, the progress is divided among the individual stations, beginning with the numerically smallest. Only if all stations available have run the disinfection, will the disinfection process be considered successfully completed.



NOTE:

The disinfection function is only available, if the circulating function is activated.

9. OPTIONAL FUNCTIONS

Stratified return	
▶ ΔT_{on}	5.0 K
ΔT_{off}	3.0 K
back	

Stratified return

Main menu / Opt. functions / Stratified return

Adjustment channel	Description	Adjustment range / selection	Factory setting
Stratified return	Activation of the function	Yes, No	No
ΔT_{on}	Switch-on temperature difference	0.5 ... 20.0 K	5.0 K
ΔT_{off}	Switch-off temperature difference	0.5 ... 20.0 K	3.0 K
back			

Exemplary representation based on the CFWME

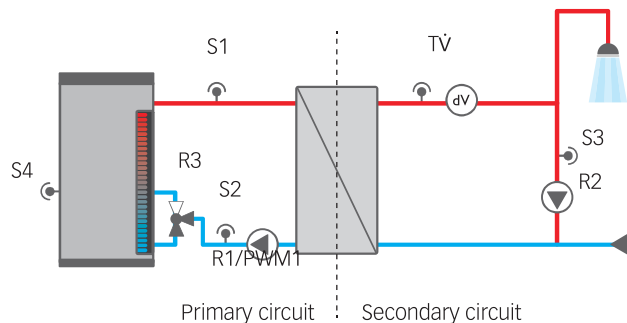

The **Stratified return** function can be used for keeping the temperature stratification inside the store from being destroyed when the circulation is running. If the temperature difference between the return sensor and the store sensor exceeds the adjustable value **Switch-on temperature difference**, the relay for the stratified return switches on. The return is then fed into the upper store zone.

If the temperature difference between the return sensor and the store sensor falls below the adjustable value **Switch-off temperature difference**, the relay switches off. The return is then fed into the lower store zone.



NOTE:

The controller uses the **sensor input S4** for measuring the temperature at the store sensor.

The 3-port valve has to be mounted in a way so that the flow direction is towards the lower store zone when the valve is without current. In order to protect the stratification in the upper store zone, the store sensor has to be mounted in the middle store zone.



NOTE:

In cascade operation, the stratified return valve has to be connected to R2 of station 2.

9. OPTIONAL FUNCTIONS

Blocking protect.	
▶ Start. time	00:30
<input checked="" type="checkbox"/> Primary p.	
<input checked="" type="checkbox"/> Circ. pump	

Blocking protection

Main menu / Opt. functions / Blocking protect.

Adjustment channel	Description	Adjustment range / selection	Factory setting
Blocking protect.	Activation of the function	Yes, No	No
Start. time	Starting time of the function	00:00 ... 23:50	00:30
Primary p.	Blocking protection primary pump	Yes, No	Yes
Line valve*	Blocking protection line valve	Yes, No	Yes
Circ. pump	Blocking protection circulation pump	Yes, No	Yes
Stratified return	Blocking protection stratified return valve	Yes, No	Yes
back			

* Available for **System type Station 1** only

The **Blocking protection** function can be used for protecting the selected pumps and valves against blocking after a standstill. The blocking protection will be carried out for the relays selected one after the other each day at the adjusted Starting time.



NOTE:

In cascade operation, the blocking protection will be carried out for all stations successively.

Error relay	
▶ Type	Normal
Level	Disturbance
back	

Error relay

Hauptmenü / Wahlfunktionen / Fehlerrelais

Adjustment channel	Description	Adjustment range / selection	Factory setting
Error relay	Activation of the function	Yes, No	No
Type	Error relay type	Inverted, Normal, Off	Off
Level	Error category of the message	Disturb., Warning, Note	Disturbance
back			

The **Error relay** function can be used for operating a relay in the case of an error. Thus, e. g. a signalling device can be connected in order to signal errors.

If the **Normal** type is selected, the controller switches the potential-free relay when a fault occurs.

If the **Inverted** type is selected, the relay always remains switched on as long as no fault occurs. If a fault occurs, the controller switches off the potential-free relay.

By means of the parameter **Level**, the error category of the message can be selected, see page 67. Depending on the selection made, the following messages are indicated:

Disturbance = Disturbances

Warning = Disturbances + warnings

Note = Disturbances + warnings + notes

10. BASIC SETTINGS

Basic settings	
▶ Time	11:55
Date	04.05.2018
<input checked="" type="checkbox"/> Auto DST	

Main menu / Basic settings

Adjustment channel	Description	Adjustment range / selection	Factory setting
Time	Adjustment of the current time	00:00 ... 23:59	-
Date	Adjustment of the date	01.01.2001 ... 31.12.2099	01.01.2010
Auto DST	Automatic daylight saving time adjustment	Yes, No	Yes
Language	Selection of the menu language	Deutsch, English	Deutsch
Type	System type for the controller	Single station, Station 1, Station 2, Station 3, Station 4	Single station
Reset	back to factory setting	Yes, No	No
back			

In the **Basic settings** menu, all basic parameters for the controller can be adjusted. Normally, these settings have been made during commissioning. They can be subsequently changed in this menu.



NOTE:

In cascade operation, a reset can be carried out on every station controller.

11. SD CARD

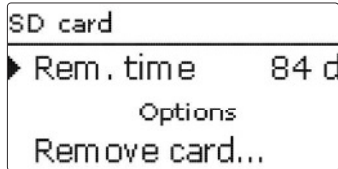

The controller is equipped with an SD card slot for SD memory cards.

With an SD card, the following functions can be carried out:

- Logging measurement and balance values. After the transfer to a computer, the values can be opened and visualised, e. g. in a spreadsheet.
- Store adjustments and parameterisations on the SD card and, if necessary, retrieve them from there.
- Running firmware updates on the controller.

Running firmware updates

When an SD card with a firmware update is inserted, the enquiry **Update?** is indicated on the display.

→ In order to run an update, select **Yes** and confirm with the right button (✓).

The update will run automatically. The indication **Please wait** and a progress bar appear on the display. When the update has been completed, the controller will automatically reboot and run a short initialisation phase.



NOTE

Only remove the card when the initialisation phase has been completed and the main menu is indicated on the controller display!

→ To skip the update, select **No**.

The controller starts normal operation.



NOTE:

The controller will only recognise a firmware update file if it is stored in a folder named **COSMO\CFWME** on the first level of the SD card.

→ Create a folder named **COSMO** on the SD card and extract the downloaded ZIP file into this folder.

Starting the logging

→ Insert the SD card into the slot.

→ Adjust the desired logging type and interval.

Logging will start immediately.

Completing the logging process

→ Select the menu item **Remove card...**

→ After **Remove card** is displayed, remove the card from the slot.

When **Linear** is adjusted in the **logging type** adjustment channel, data logging will stop if the capacity limit is reached. The message **Card full** will be displayed.

If **Cyclic** is adjusted, the oldest data logged onto the SD card will be overwritten as soon as the capacity limit is reached.



NOTE:

Because of the increasing size of the data packets, the remaining logging time does not decrease linearly. The data packet size can increase, e. g. with the increasing operating hours value.

Storing controller adjustments

→ To store the controller adjustments on an SD card, select the menu item **Save adjustments**.

While the adjustments are being stored, first **Please wait**, then **Done!** will be indicated on the display. The controller adjustments are stored as a .SET file on the SD card.

11. SD CARD

Loading controller adjustments

→ To load controller adjustments from an SD card, select the menu item **Load adjustments**.

The **file selection** window will appear.

→ Select the desired .SET file.

While the adjustments are being loaded, first **Please wait**, then **Done!** will be indicated on the display.



NOTE:

To safely remove the SD card, always select the menu item **Remove card...** before removing the card.



NOTE:

In cascade operation, the **SD card** menu will be available on each station controller. In order to log cascade values, store or load controller adjustments, insert an SD card into each controller of the cascade.

Main menu / SD card

Adjustment channel	Description	Adjustment range / selection	Factory setting
Remove card...	Safely remove card	-	-
Save adjustments	Save adjustments	-	-
Load adjustments	Load adjustments	-	-
Logging int.	Logging interval	00:01 ... 20:00 (mm:ss)	01:00
Logging type	Logging type	Cyclic, Linear	Linear

12. USER CODE

User code:

0000
▲

In the **User code** menu, a user code can be entered. Each number of the 4-digit code must be individually adjusted and confirmed. After the last digit has been confirmed, the menu automatically jumps to the superior menu level.

To access the menu areas of the installer level, the installer user code must be entered:

Installer: 0262

If the installer user code has been entered, the controller changes to the parameterisation mode, see page 50.



NOTE:

For safety reasons, the user code should generally be set to the customer code before the controller is handed to the customer!

Customer: 0000

13. MANUAL MODE

Manual mode	
▶ Primary p.	Auto
Circ. pump	Auto
Line valve	Auto

In the **Manual mode** menu, the operating mode of all relays used can be adjusted.

Auto = Relay in automatic mode

0... 100% = Pump running at adjusted speed (manual mode)

Centre / Base = Valve in adjusted position

Open / Closed* = Valve open or closed

Error / OK = Error relay in **Error** or **OK** mode



NOTE:

After service and maintenance work, the relay mode must be set back to **Auto**. Otherwise normal operation will not be possible.

Main menu / Manual mode

Adjustment channel	Description	Adjustment range / selection	Factory setting
Primary p.	Operating mode selection for the primary pump	Auto, 0... 100%	Auto
Line valve*	Operating mode selection for the line valve	Auto, Open, Closed, Off	Auto
Circ. pump	Operating mode selection for the circulation pump	Auto, 0... 100%	Auto
Strat.ret.	Operating mode selection for the stratified return valve	Off, Centre, Base, Auto	Auto
Error relay	Operating mode selection for the error relay	Error, OK, Auto	Auto

* Available in cascade operation only



NOTE:

In cascade operation, adjust the manual mode of the relay at the corresponding station.

14. TROUBLESHOOTING

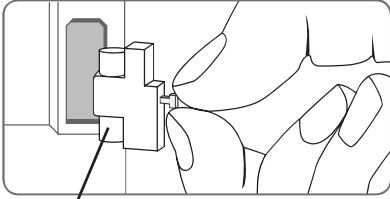

Fuse

WARNING!



Electric shock!

Upon opening the housing, live parts are exposed!

→ Always disconnect the device from power supply before opening the housing!

The controller is protected by a fuse. The fuse holder (which also holds the spare fuse) becomes accessible when the cover is removed. To replace the fuse, pull the fuse holder from the base.

If a malfunction occurs, a message will appear on the display of the controller.

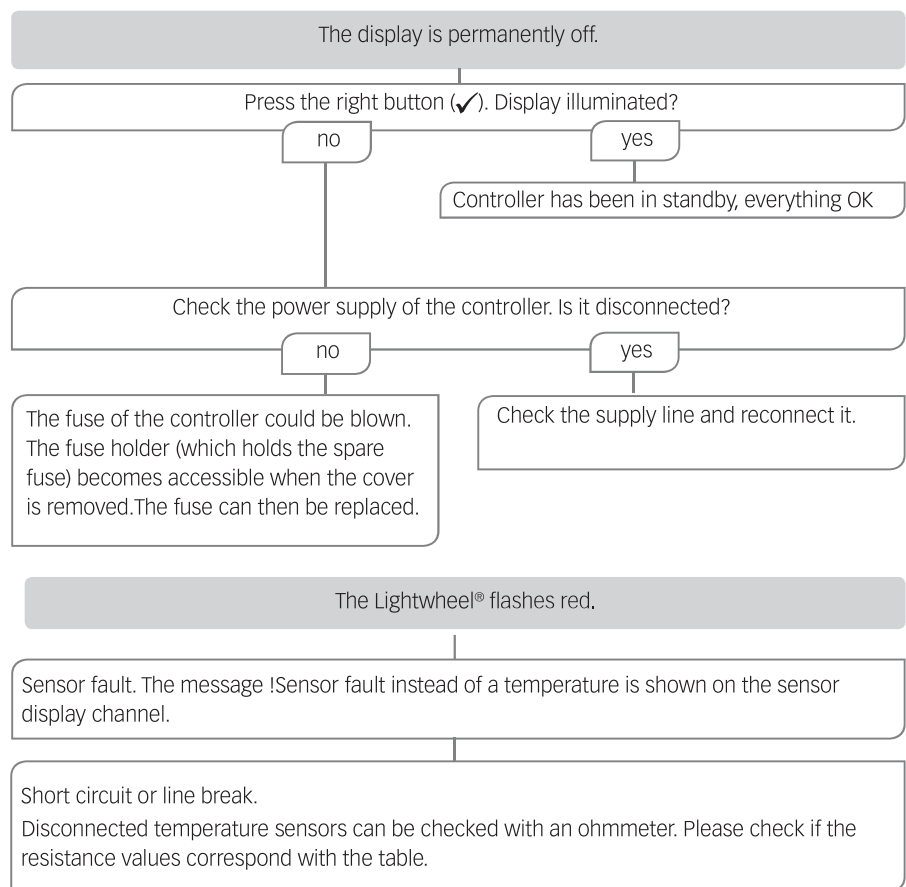

°C	Ω Pt1000	°C	Ω Pt1000
-10	961	55	1213
-5	980	60	1232
0	1000	65	1252
5	1019	70	1271
10	1039	75	1290
15	1058	80	1309
20	1078	85	1328
25	1097	90	1347
30	1117	95	1366
35	1136	100	1385
40	1155	105	1404
45	1175	110	1423
50	1194	115	1442

14. TROUBLESHOOTING

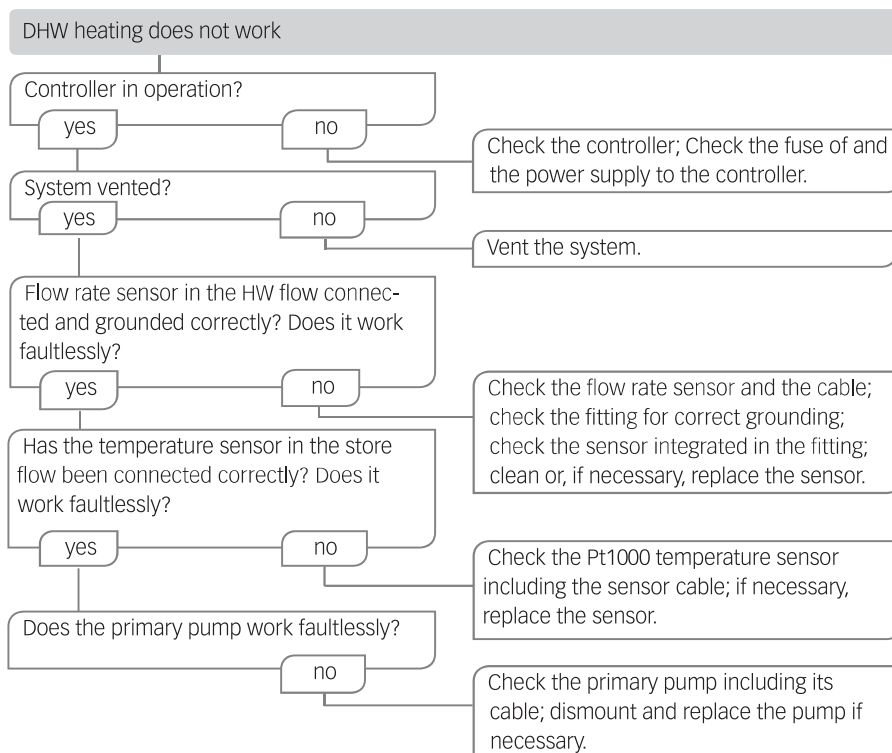
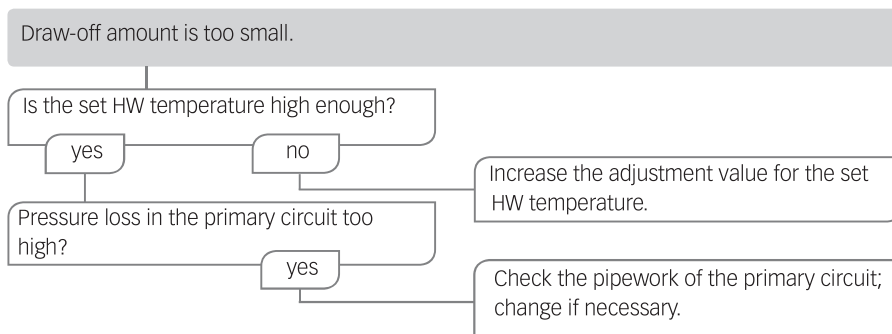
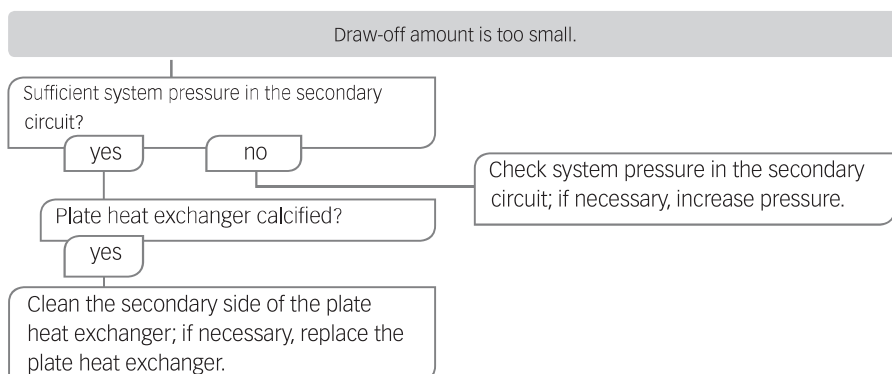
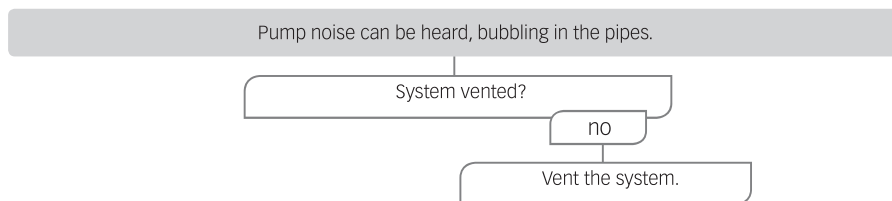

15. INDEX

B	
Blocking protection	77
C	
Comfort mode	73
Commissioning menu	59
Controller adjustments	80
D	
Data logging.....	79
Disinfection.....	75
E	
Electrical connection.....	48
Emergency speed.....	71
Error relay	77
F	
Firmware updates	79
Fuse.....	82
L	
Lightwheel®.....	52
M	
Manual mode.....	81
Measured values	67,68
Microbuttons	52
MicroSD card slot	49
Mounting.....	48
O	
Operating control LED	52
Operating mode, relays	81
S	
SD card.....	80
Sensor fault, error message.....	69
Set hot water temperature.....	70
Sliding set value.....	70
Standalone controller emergency operation	71
Stratified return.....	76
T	
Technical data.....	47
Troubleshooting.....	82
U	
User code.....	80

16. EU DECLARATION OF CONFIRMITY



COSMO GMBH

Brandstücken 31
22549 Hamburg



For the following product

DHW exchange controller COSMO CFWME

it is herewith confirmed that it complies with the standards, which are determined in Council Directives on the approximation of the laws of the Member states.

For the evaluation of the product, the following directives and standards were used in the version current at the date of issue:

Reference	Title
2014/30/EU	Electromagnetic Compatibility Directive
2014/35/EU	Low Voltage Directive
2011/65/EU	RoHS II
Reference	Title
EN 55014-1: 2012-05	Electromagnetic Compatibility – Part 1
EN 55014-2: 2016-01	Electromagnetic Compatibility – Part 2
EN 60335-1: 2014-11	Household and similar electrical appliances – Safety
EN 60730-1: 2012-10	Automatic electronic controls for household and similar use
EN 60730-2-9: 2011-07	Automatic electronic controls for household and similar use Particular requirements for temperature sensing controls

This declaration is issued under the sole responsibility of the manufacturer

NOTE

NOTE

NOTE

17. GUARANTEE, WARRANTY, AVAILABILITY GUARANTEE, IMPRINT

COSMO GmbH

Brandstücken 31

22549 Hamburg

Managing Director: Hermann-Josef Lüken

Phone: +49 40 80030430

HRB 109633 (Local Court Hamburg)

info@cosmo-info.de

www.cosmo-info.de

2nd issue Okt 2019

Subject to technical changes, errors excepted.
All images, dimensions, product- and design-related information are valid at the date of printing.

We reserve the right to make technical changes as well as changes in colour and form of the illustrated products without notice.

Colours may differ due to printing process.
Model and product claims cannot be asserted.

Within the scope of the currently valid legal provisions of the purchase contract law (German Civil Code (BGB) in regard to warranty claims for defects), a limitation period of 5 years from delivery applies to COSMO.





COSMO GMBH
Brandstücken 31 · 22549 Hamburg

info@cosmo-info.de
www.cosmo-info.de